

Diaz

Proudly Aussie made

All dimensions in mm

DZ122

Single Bowl Topmount Sink With Drainer

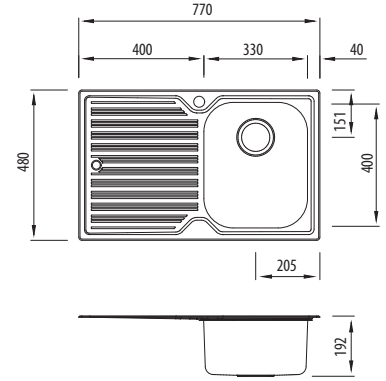

Specifications /

Sink size	770W x 480H mm
Bowl size	Main Bowl 330W x 400H x 180D / 21L
Construction	2 piece, bowls and drainer seam welded
Material	304 grade, 18/10 polished stainless steel (0.8 mm thick)
Installation	Topmount recommended
Fixings	Adjustable clips and sealing foam supplied
Min cabinet size	500 mm
Tap holes	Available 0 or 1 tap hole (specify when ordering)
Waste fittings	1 x 90 mm basket waste included
Overflow	Not available
Carton size	780 x 490 x 200 mm
Weight	5.5 kg
Warranty	Lifetime manufacturer's warranty (refer to oliveri.com.au)
Maintenance and care instructions	All surfaces should be cleaned with mild liquid detergent or soap and water. To maintain the shine on your Oliveri stainless steel sink, we recommended the use of any of the easy to obtain, non-abrasive stainless steel cleaners or metal polishes.

Included accessories /



AC14
Basket Waste



AC18
Colander



AC15
Bamboo Board



For more information call 1300 13 7465 or visit oliveri.com.au

BATHROOM COLLECTIVE

Phone Number: (02) 9011-5711