

Santorini

Italian made

All dimensions in mm

ST-MB1512 OF

Matte Black 1 & 3/4 Bowl Topmount Sink With Drainer

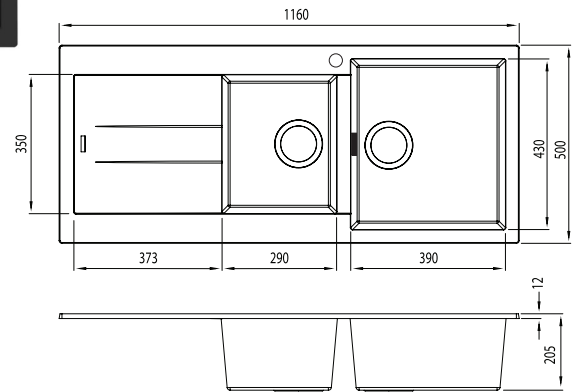
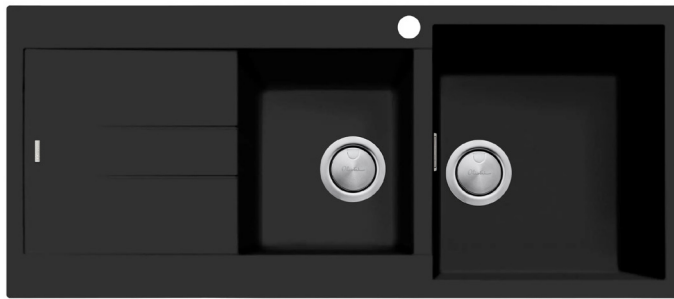

— Overflow location

Specifications /

Sink size	1160W x 500H mm
Bowl size	Main Bowl 1 400W x 430H x 210D / 36L 3/4 Bowl 295W x 350H x 210D / 21L
Construction	Moulded granite
Material	80% granite and quartz particles and 20% acrylic
Installation	Topmount
Fixings	Topmount clips supplied
Min cabinet size	800 mm
Tap holes	One tap hole only
Waste fittings	2 x 90 mm basket wastes included
Overflow	Overflow kit included
Carton size	1260 x 290 x 320 mm
Weight	19 kg
Warranty	Lifetime manufacturer's warranty (refer to Oliveri website)
Maintenance and care instructions	Clean the sink regularly with warm water, a liquid detergent and a soft cloth. Do not use abrasive powders or creams and avoid chemically aggressive detergents. Generic stains should be removed immediately with very hot water and a cleaning product. For organic stains which are especially difficult to remove, it is recommended that you fill the sink with a highly diluted organic cleaner such as bleach and let stand overnight. The next morning, rinse with warm water and a soft cloth.

Included accessories /

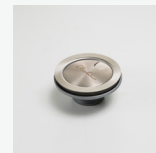

AC28
Basket Waste



AC10
Basket Waste with Rectangular Overflow



For more information call 08 8348 6444 or visit oliveri.com.au

BATHROOM COLLECTIVE

Phone Number: (02) 9011-5711