



PRODUCT SPECIFICATION

30727

PEGASI WALL SINK SPOUT 200 SWIVEL

FEATURES

- WELS 4* 7.5 lpm
- Swivel spout reach 200 mm
- Recessed aerator
- WELS registration number T32371 / T32371 (V)

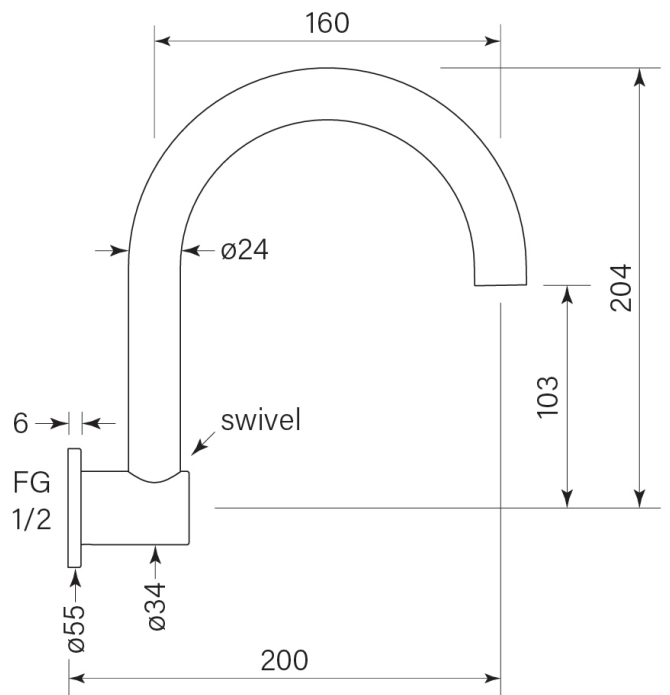

BATHROOM COLLECTIVE

Phone Number: (02) 9011-5711