



PRODUCT SPECIFICATION

35121

ZEOS BACK PLATE BASIN MIXER 200

FEATURES

- Solid brass handle
- WELS 5* 6 lpm
- Reach 200 mm
- 2 stage flow step cartridge
- Includes Logikit™ body
- WELS registration number T41029

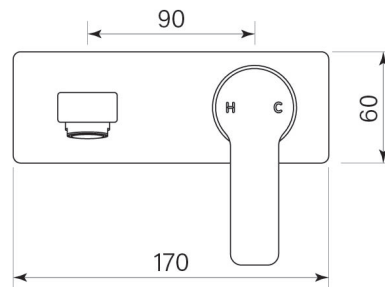
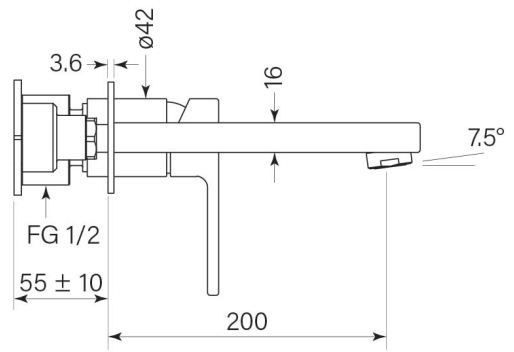

BATHROOM COLLECTIVE

Phone Number: (02) 9011-5711