



PRODUCT SPECIFICATION

30534

CASCADE BACK PLATE BASIN MIXER 250

FEATURES

- WELS 5* 6 lpm
- Reach 250 mm
- 2 stage flow step valve
- Includes Logikit™ body
- Recessed aerator

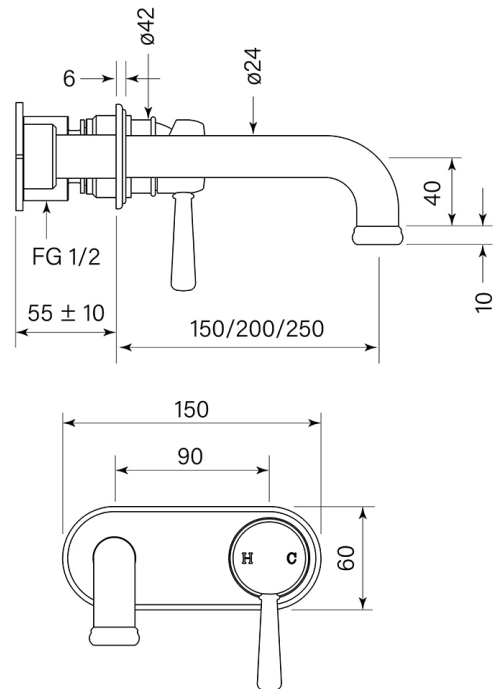

BATHROOM COLLECTIVE

Phone Number: (02) 9011-5711