



PRODUCT SPECIFICATION

30536

CASCADE BACK PLATE BATH MIXER 200

FEATURES

- Free flow
- Reach 200 mm
- 2 stage flow step valve
- Includes Logikit™ body
- Recessed flow straightener

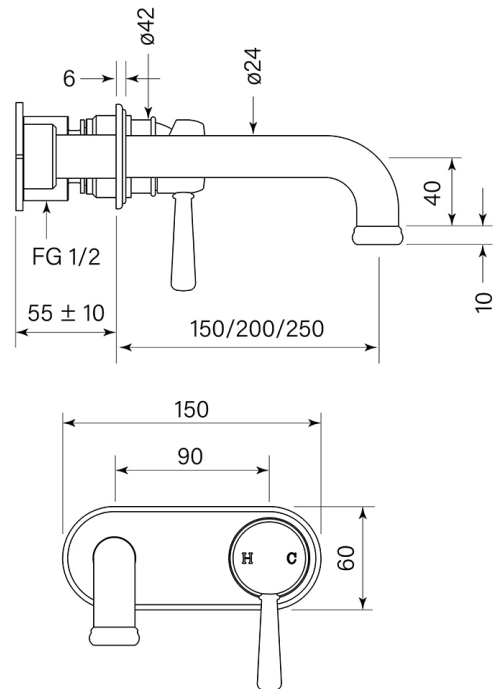

**BATHROOM COLLECTIVE**

Phone Number: (02) 9011-5711