



PRODUCT SPECIFICATION

30537

CASCADE BACK PLATE BATH MIXER 250

FEATURES

- Free flow
- Reach 250 mm
- 2 stage flow step valve
- Includes Logikit™ body
- Recessed flow straightener

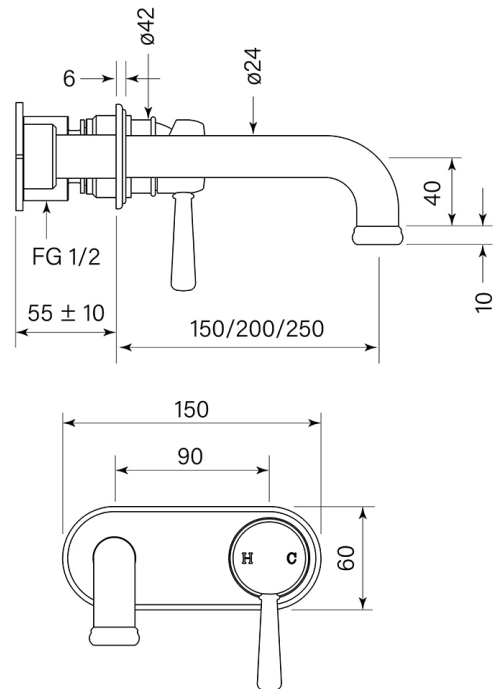

**BATHROOM COLLECTIVE**

Phone Number: (02) 9011-5711