



PRODUCT SPECIFICATION

30539

CASCADE BASIN MIXER SET 200

FEATURES

- WELS 5\* 6 lpm
- Reach 200 mm
- 2 stage flow step valve
- Includes Logikit™ body
- Recessed aerator

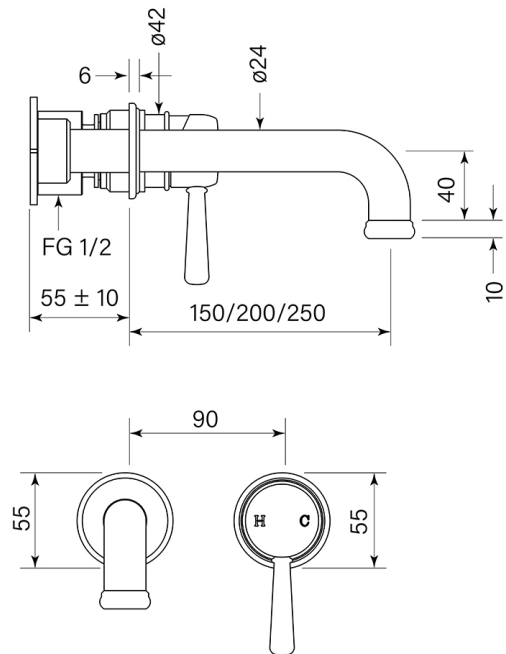

**BATHROOM COLLECTIVE**

Phone Number: (02) 9011-5711