

Circa Twin shower

SUSSEX

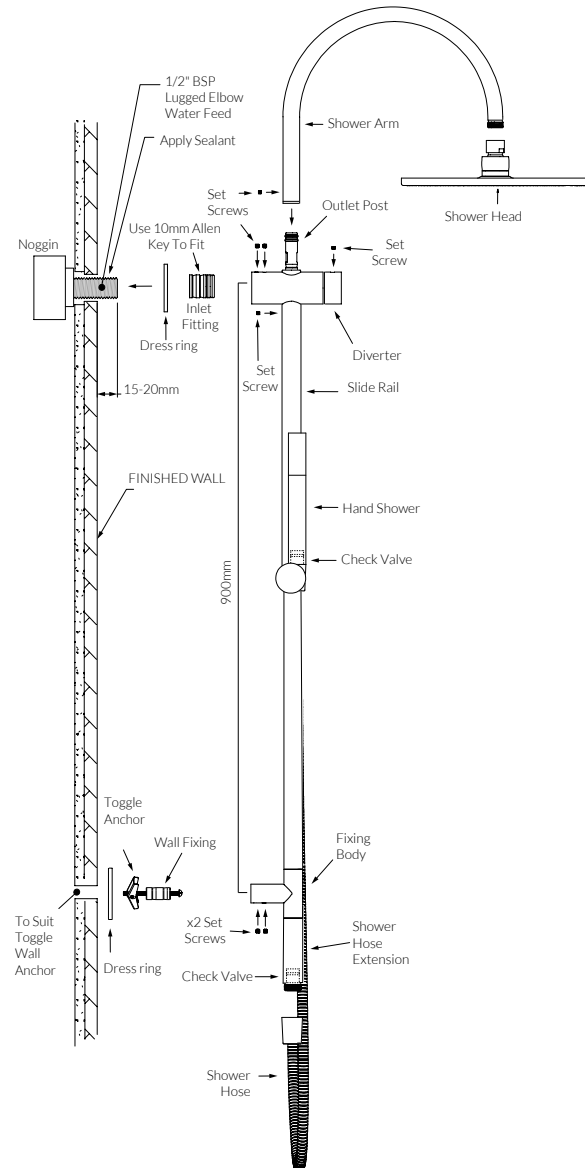

Spring Toggle Wall Anchor

- For fixing into hollow wall materials such as plasterboard, hardboard, plywood, cement sheeting, hollow block, etc.
- Applications: Towel rails, shelving, cupboards, wall lights, etc.
- MUST HAVE A CLEAR AIR SPACE BEHIND THE MATERIAL BEING FASTENED TO.

INSTALLATION INSTRUCTIONS

1. Drill a 14mm diameter hole through the material to which the Spring Toggle is being fastened to.
2. Pass the screw through the fixture into toggle for a few turns. Compress the toggle wings and insert the anchor into the hole. The wings will spread behind the cavity wall.
3. Pull back on the fixture to hold the toggle in place against the reverse side of cavity wall and tighten screw with a screwdriver, pulling the wings of the anchor firm against the cavity wall.

RECOMMENDED MAX LOAD 10KG IN 10MM PLASTERBOARD.

Product code

RTRS Twin shower

Installation guidelines

- The Rail is supplied part assembled to suit a Bottom Water Inlet installation.
- For bottom water inlet installation see following page.
- Remove Inlet Fitting and Wall Fixing by loosening the Set Screws.
- Accurately mark out and drill for the Wall Fixing 900mm from centre of Water Feed (see Spring Toggle Wall Anchor guide).
- Ensure the wall penetration is sealed prior to connecting any fittings.
- Apply thread tape or appropriate sealant to Water Feed Thread and attach Inlet Fitting using 10mm Allen key.
- Using the provided Spring Toggle Anchor attach the Wall Fixing.
- Fit the Rail Shower as assembled onto the Wall Fixing and Inlet Fitting, secure by tightening the Set Screws
- Align and fit the Shower Arm over the Outlet Post.
- Secure Shower Arm by tightening Set Screws. (tighten well).
- Attach Shower Head, tighten using spanner.
- Test function and water flow on both Shower Head and Hand Shower.
- Check for water leaks.

Circa Twin shower

SUSSEX

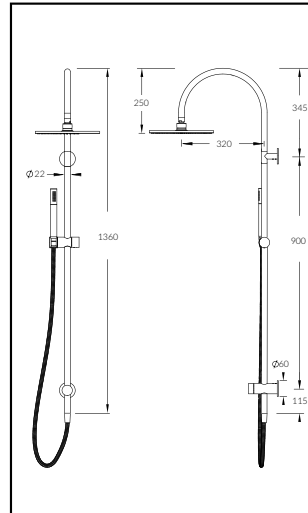
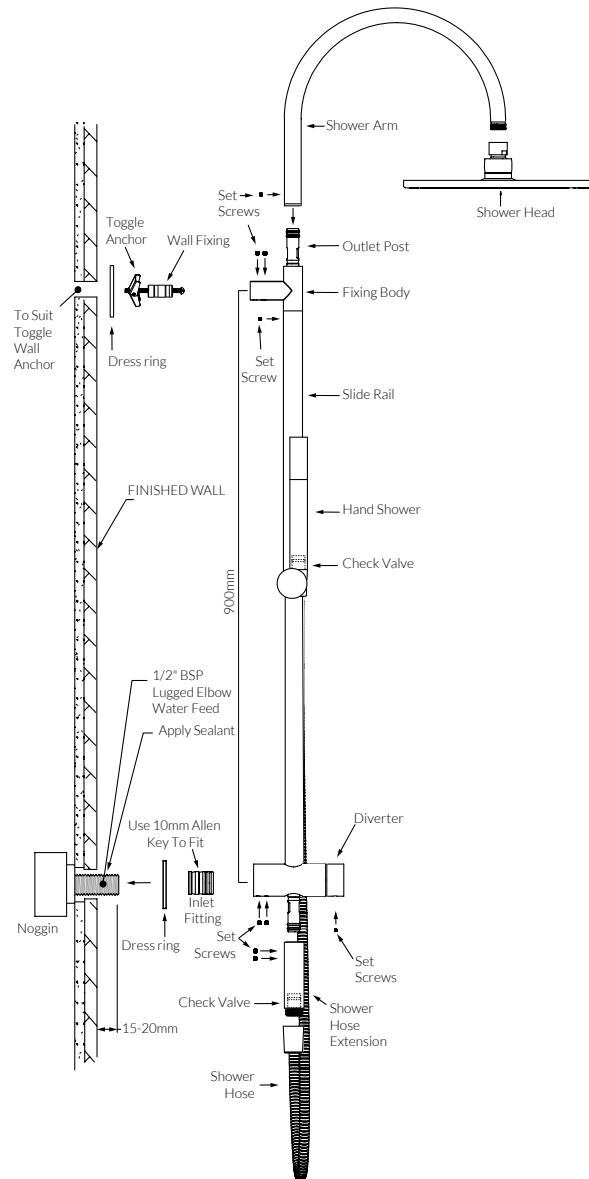

Spring Toggle Wall Anchor

- For fixing into hollow wall materials such as plasterboard, hardboard, plywood, cement sheeting, hollow block, etc.
- Applications: Towel rails, shelving, cupboards, wall lights, etc.
- MUST HAVE A CLEAR AIR SPACE BEHIND THE MATERIAL BEING FASTENED TO.

INSTALLATION INSTRUCTIONS

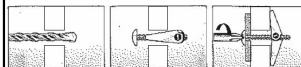

1. Drill a 14mm diameter hole through the material to which the Spring Toggle is being fastened to.
2. Pass the screw through the fixture into toggle for a few turns. Compress the toggle wings and insert the anchor into the hole. The wings will spread behind the cavity wall.
3. Pull back on the fixture to hold the toggle in place against the recess side of cavity wall and tighten screw with a screwdriver, pulling the wings of the anchor firm against the cavity wall.

RECOMMENDED MAX LOAD 10KG IN 10MM PLASTERBOARD.

- To change the Water Inlet position, the Diverter, Fixing Body and Shower Hose Extension will need to be disassembled (See. following page).
- No additional component will be required.

Circa Twin shower

SUSSEX

- 1.** - Remove Diverter and Fixing Body by loosening Set Screw.

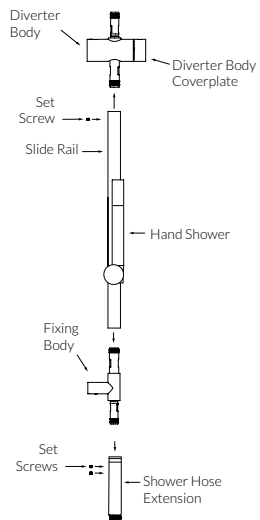

- 2.** - Swap the Diverter Body and Fixing Body positions.
- Diverter body will now be located at the bottom.
- Fixing body will now be located at the top.

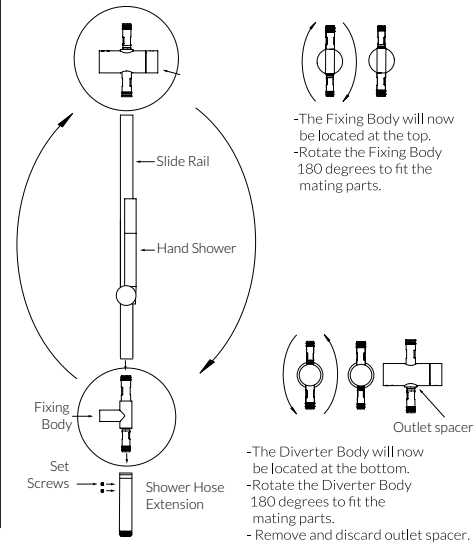

- 3.** - Re-attach the Fixing Body and the Diverter Body to Slide rail. Tighten Set Screw.
- Re-attach Shower Hose Extension. Tighten Set Screws.
- Attach Shower Arm and Head. Align Shower Arm and Tighten Set Screw.
- Attach shower rose.

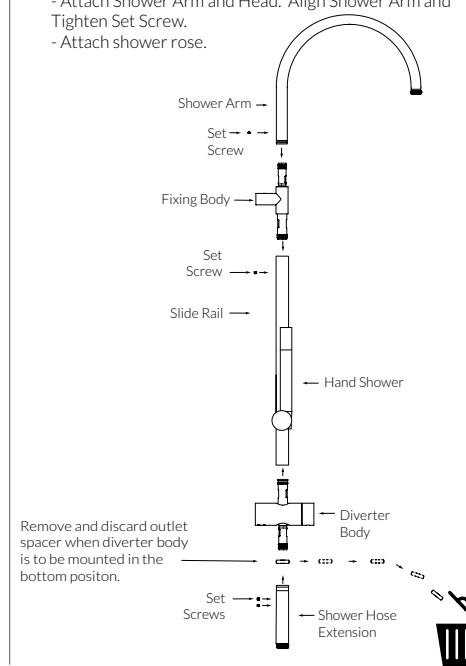

- 4.** - Proceed with installation fit off (see page 1)

