

Calibre Wall basin hostess system 200mm

SUSSEX

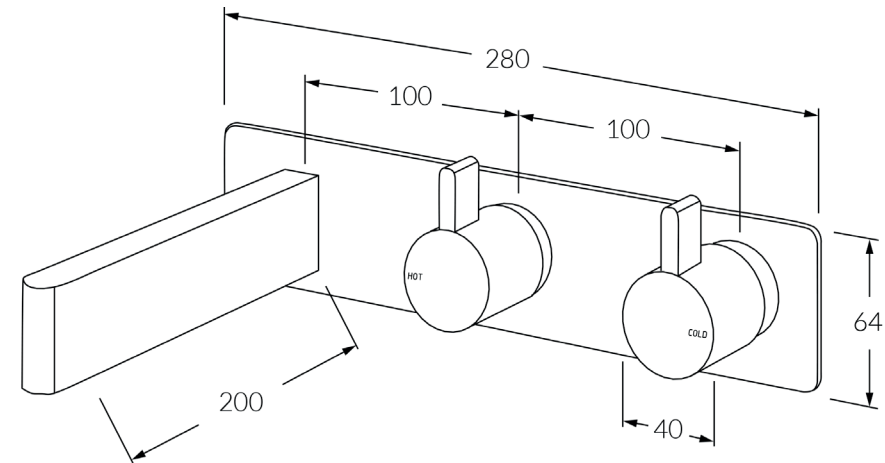
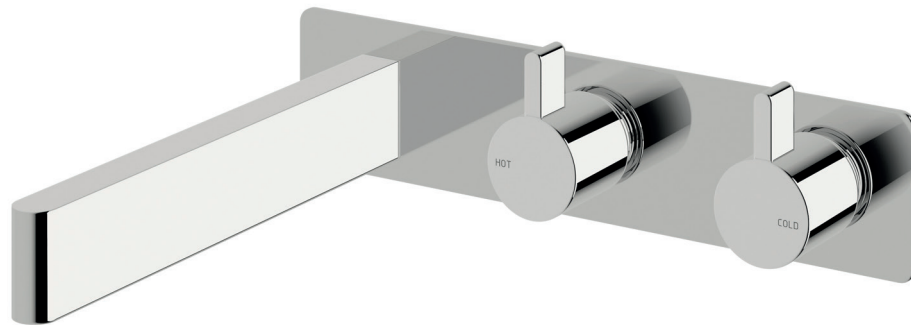

Product code

CWBHS200RH

Product features

- Designed and manufactured in Australia
- All brass construction
- 1/2 turn ceramic disc spindles
- Fixed handle lever
- Incorporating Sussex Masterfit
- Available in a range of high quality, durable finishes inc. LUXPVD®
- Minimal, refined design to complement any contemporary space
- Matching tapware and showers

sussex taps.com.au

Warranty

15 Year overall warranty.
Refer to Warranty sheet for specific information.

Pressure rating

300 - 500kPa

Temperature rating

1 - 65°C

WELS rating

5 star - 5lt/min



BATHROOM COLLECTIVE

Phone Number: (02) 9011-5711

While we aim to ensure the specifications shown are correct at time of printing, Sussex Taps reserves the right to make modifications without prior notice. Always use the physical product for accurate measurements. Dimensions are subject to change without notice. All measurements are shown in millimetres.

Copyright © Sussex Taps