

Circa Vertex Wall bath hostess system 250mm

SUSSEX

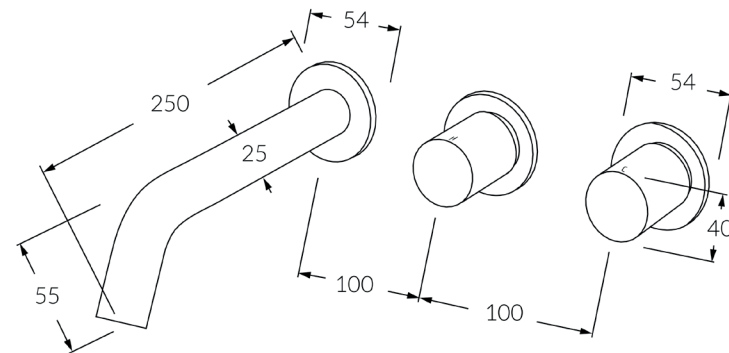

Product code

RBHS250RH-V

Product features

- Designed and manufactured in Australia
- All brass construction
- Textured handle
- 1/2 turn ceramic disc spindles
- Incorporating Sussex Masterfit
- Customisable
- Available in a range of high quality, durable finishes inc. LUXPVD®
- Minimal, refined design to complement any contemporary space
- Matching tapware and showers

Warranty

15 Year overall warranty.
Refer to Warranty sheet for specific information.

Pressure rating

300 - 500kPa

Temperature rating

1 - 65°C

BATHROOM COLLECTIVE

Phone Number: (02) 9011-5711



AS/NZS 3718:2005
LIC. 20081