

CONO BUILT-IN WASHBASIN

- Harmonious washbasin with a premium character
- Enamelled waste integrated optimally to round off the geometric appearance perfectly
- The perfect addition to the CONO family
- Extremely generous space for fittings and individual accessories

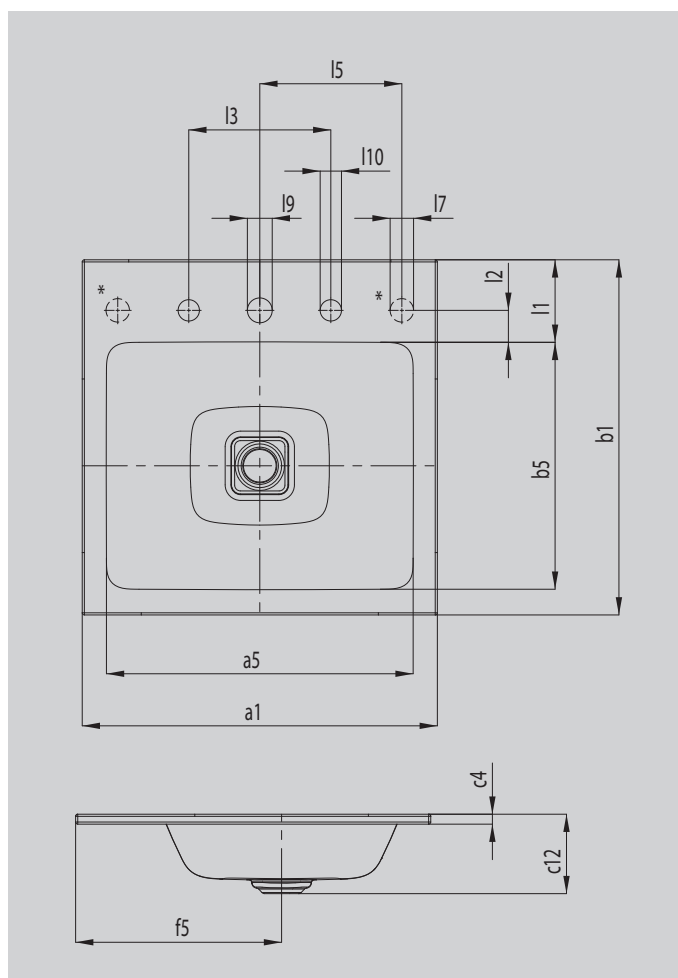

Similar illustration



Model		3080
External length [mm]	a ₁	600 mm
Internal length [mm]	a ₅	532 mm
External width [mm]	b ₁	500 mm
Internal width [mm]	b ₅	348 mm
Height of rim [mm]	c ₄	14 mm
Distance basin surface to bottom edge of waste hole [mm]	c ₁₂	112 mm
Distance rear edge to centre of waste hole [mm]	f ₅	290 mm
Depth of tap deck [mm]	l ₁	116 mm
Distance tap holes to edge [mm]	l ₂	45 mm
Distance external tap holes (for 3 tap holes) [mm]	l ₃	200 mm
Diameter of centre tap hole [mm]	l ₉	Ø 35 mm
Diameter of outside tap hole (for 3 tap holes only) [mm]	l ₁₀	Ø 30 mm
Net weight [kg]		7 kg

BATHROOM COLLECTIVE

Phone Number: (02) 9011-5711

KALDEWEI

Subject to technical alterations, tolerances and errors. Similar illustration.