

SILENIO BUILT-IN WASHBASIN

- Fluid and sensually modern design all at once
- Optimum comfort through generous dimensioning of the washbasin
- Soft, organic interior shape
- Geometry allows fittings with short spout leaving ample space for washing
- Together with the SILENIO bath and SCONA shower surface, they form a perfect bathroom fitted out entirely with steel enamel
- Designed by Anke Salomon

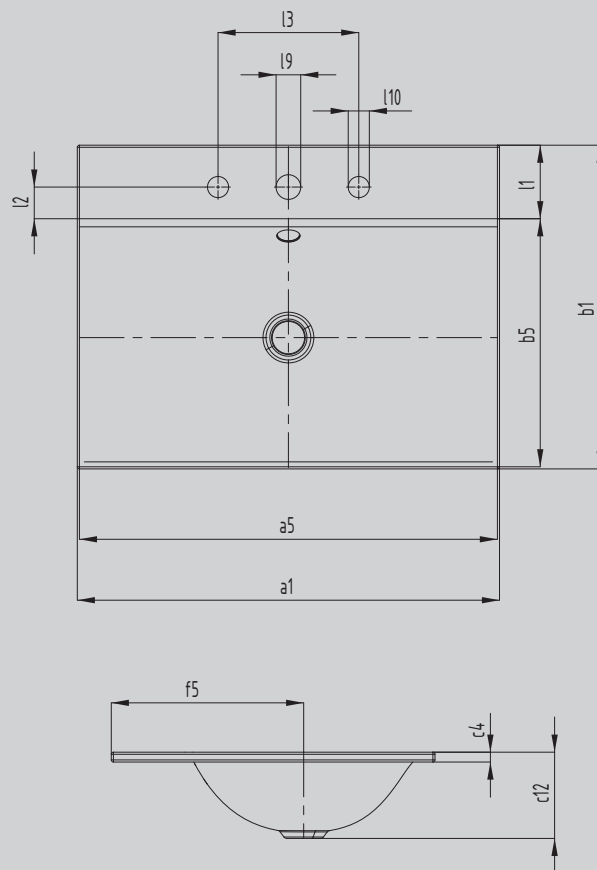

Similar illustration



Model		3037
External length [mm]	a_1	600 mm
Internal length [mm]	a_5	594 mm
External width [mm]	b_1	460 mm
Internal width [mm]	b_5	353 mm
Height of rim [mm]	c_4	14 mm
Distance basin surface to bottom edge of waste hole [mm]	c_{12}	123 mm
Distance rear edge to centre of waste hole [mm]	f_5	274 mm
Depth of tap deck [mm]	l_1	105 mm
Distance tap holes to edge [mm]	l_2	45 mm
Distance external tap holes (for 3 tap holes) [mm]	l_3	200 mm
Diameter of centre tap hole [mm]	l_9	Ø 35 mm
Diameter of outside tap hole (for 3 tap holes only) [mm]	l_{10}	Ø 30 mm
Net weight [kg]		7 kg

BATHROOM COLLECTIVE

Phone Number: (02) 9011-5711

KALDEWEI

Subject to technical alterations, tolerances and errors. Similar illustration.