

kreoo

Listino prezzi | Price List
2023

Bath Collection

Indice | Index

Bath
Collection



8 | Pearl Airpool



9 | Venice



10 | Kalypso



11 | Kora



12 | Hug Tub



13 | Hug Freestanding



14 | Dame Freestanding



15 | Dame Bowl



16 | Blessed Circle



17 | Blessed Square



18 | Roma



21 | Tao



22 | Bubbles



24 | Gong



26 | Cashmere



28 | Athene



29 | Dry



30 | Bento



31 | Loto



34 | Nami



35 | Diamond



36 | Bowl 1



37 | Bowl 2



38 | Bowl 3



39 | Bowl 4



40 | Bowl 6



41 | Bowl 8



42 | Bowl 9



43 | Bowl 10



44 | Piletta | Drain



45 | Optional Shades



46 | Trays



47 | Wood Top



48 | Linear



49 | Stick



50 | Kato



52 | Hashi



56 | Fairy



57 | Ever



58 | Arcaico



61 | Ellenico



62 | Kalende



63 | Pluvio



64 | More



66 | Jackie



67 | John

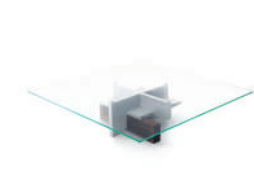

68 | Tangram Mini



69 | Keir Table



70 | Nodo



72 | Moon



73 | Keir



74 | Pavè Stones



76 | Pavè Log



77 | Pavè Drink



78 | Oasi



79 | Pedina



80 | Torre



81 | Torre Maxi



82 | Vis à Vis



84 | Shiro



85 | Tetris



86 | Royal



90 | Texo



91 | Panama



92 | Ducale Collection



93 | Rondò



94 | Merletto



95 | Fortune



96 | Weave



97 | Twirl



98 | Stone City



99 | Picto



100 | Rose



101 | Zen



102 | Folium

Pearl Airpool | Tub

- Peso netto senz'acqua: 265 kg
- Peso vasca riempita d'acqua: 635 kg
- Volume cassa: 200x112x100cm
- Peso lordo: 360 Kg
- Net weight empty: 265 kg
- Tub weight with water: 635 kg
- Crate volume: 200x112x100cm
- Gross weight: 360 kg

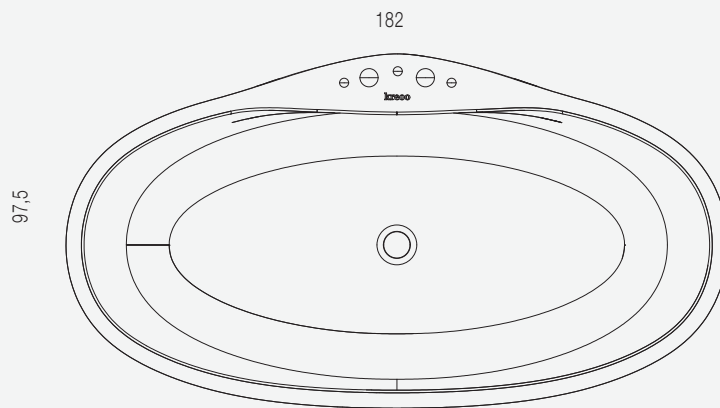
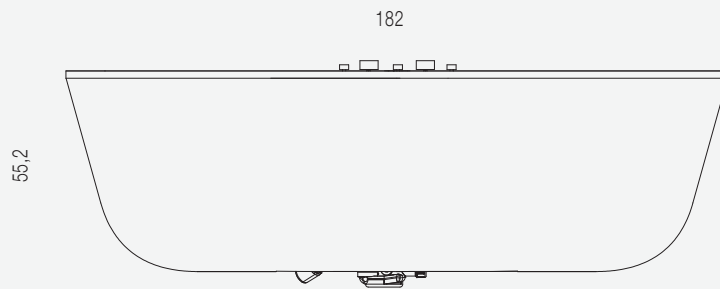

Marmo / Marble

Olive Grey

***Ral interna personalizzabile
***internal ral can be customized

BATHROOM COLLECTIVE

- Peso netto senz'acqua
282 kg
- Volume della cassa:
194x98x78 cm
- Peso lordo: 360 Kg
- Net weight empty 282 kg
- Crate volume:
194x98x78 cm
- Gross weight: 360 kg

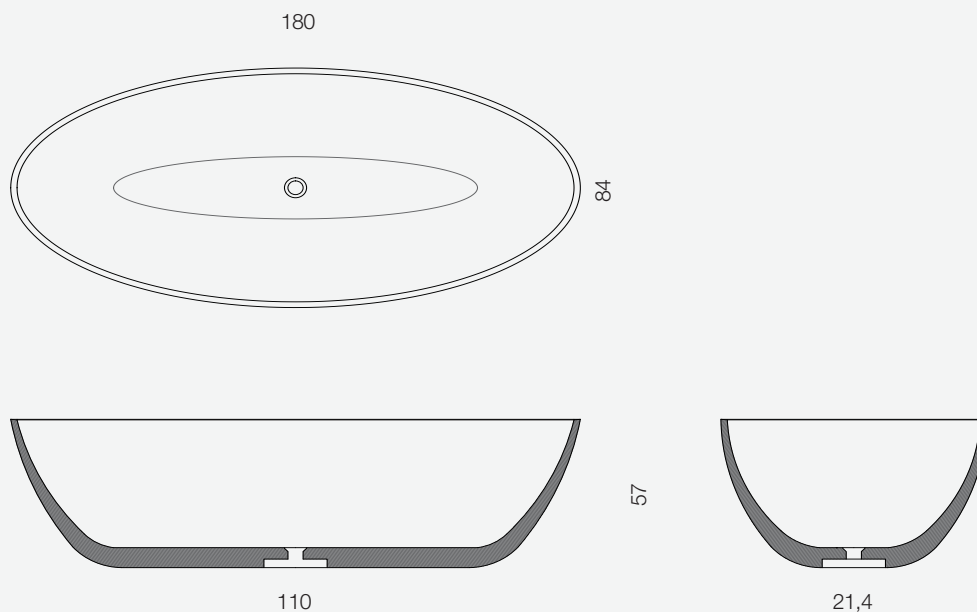

Marmo / Marble

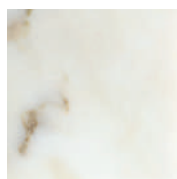

Bianco del Re



Calacatta Carrara



Bianco Carrara

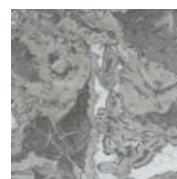

Grigio St. Marie

Marmo / Marble

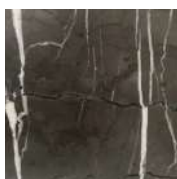

Persian Grey

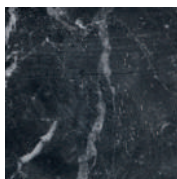

Nero Marquina

Kalypso

- Peso netto senz'acqua: 350 kg
- Volume della cassa: 186x86x86 cm
- Peso lordo: 430 kg

- Net weight empty: 350 kg
- Crate volume: 186x86x86 cm
- Gross weight: 430 kg

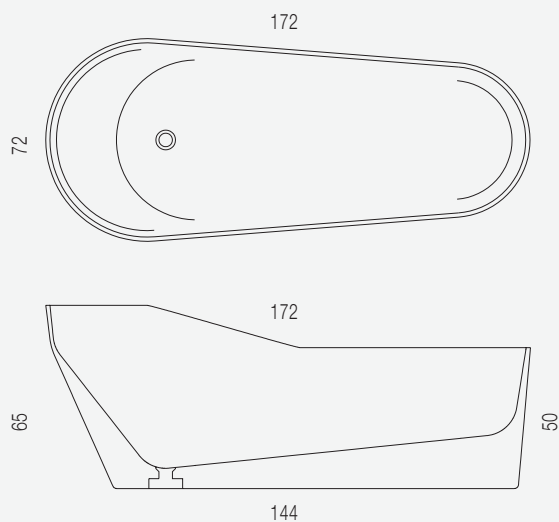

Marmo / Marble

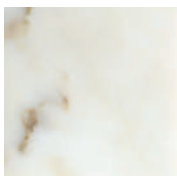

Bianco del Re



Calacatta Carrara



Bianco Carrara



Grigio St. Marie

Marmo / Marble



Grigio Bardiglio Light

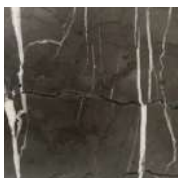

Persian Grey

BATHROOM COLLECTIVE

- Peso netto senz'acqua: 305 kg
- Volume della cassa: 184x98x95 cm
- Peso lordo: 398 kg

- Net weight empty: 305 kg
- Crate volume: 184x98x95 cm
- Gross weight: 398 kg

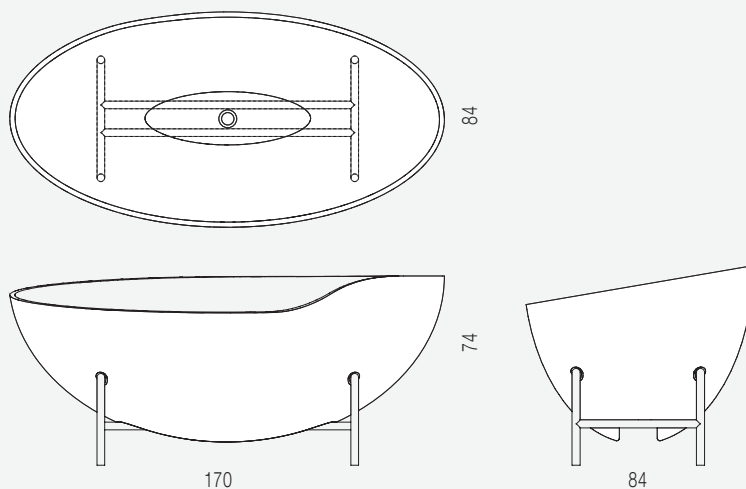

Marmo / Marble

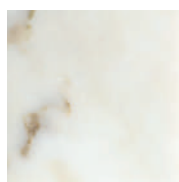

Bianco del Re



Calacatta Carrara



Bianco Carrara



Grigio St. Marie

Marmo / Marble



Grigio Bardiglio Light

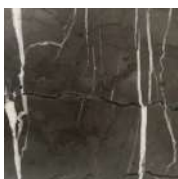

Persian Grey

Metal / Metal

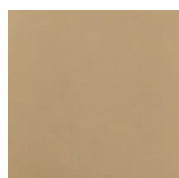

Bronzo Oro
Gold Bronze

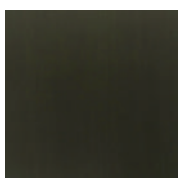

Bronzo Scuro
Dark Bronze



Nero Opaco
Matt Black

BATHROOM COLLECTIVE

- Peso netto senz'acqua: 450 kg
- Volume della cassa: 194x104x71 cm
- Peso lordo: 530 kg
- Net weight empty: 450 kg
- Crate volume: 194x104x71 cm
- Gross weight: 530 kg

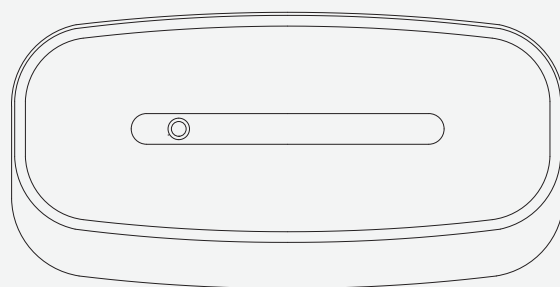

180

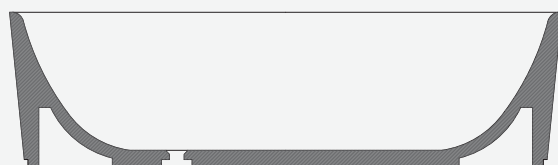

170

90

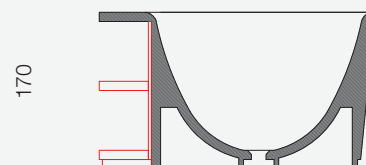

170

84

Marmo / Marble

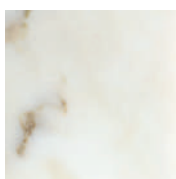

Bianco del Re



Calacatta Carrara

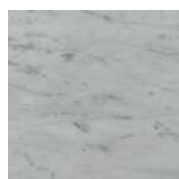

Bianco Carrara

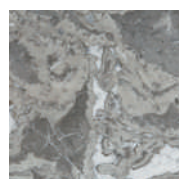

Grigio St. Marie

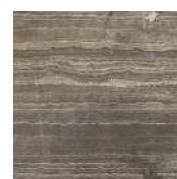

Travertino Titanium

Marmo / Marble

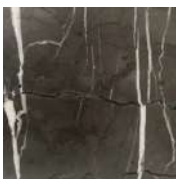

Persian Grey



Nero Marquina

Legno / Wood



Eucalipto Frisé
Eucalyptus Frisé



Noce Matt
Walnut Matt

finiture legno disponibili Eucalipto Frisé / Noce matt
***available wood finishes Eucalyptus Frisé / Walnut matt

- Peso: 226 kg
- Volume della cassa: 66x66x124 cm
- Peso lordo: 301 kg
- Weight: 226 kg
- Volume of the crate: 66x66x124 cm
- Gross weight: 301 kg

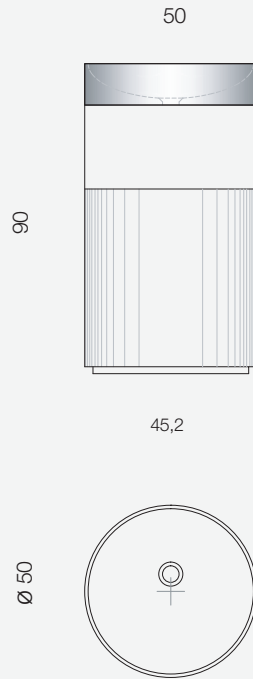

Marmo / Marble

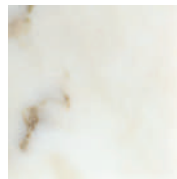

Bianco del Re



Calacatta Classico



Bianco Carrara

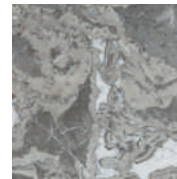

Grigio St. Marie



Travertino Titanium

Marmo / Marble



Persian Grey

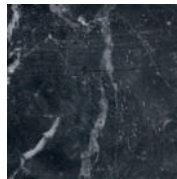

Nero Marquina

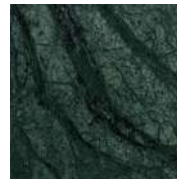

Verde Imperiale

Legno / Wood



Eucalipto Frisé
Eucalyptus Frisé



Noce Matt
Walnut Matt

Per ordinativi di 2 pezzi o superiori dello stesso materiale, ulteriore sconto -10%

For orders including 2 or more pieces of the same material, please apply a further discount -10% on the price reported.

finiture legno disponibili Eucalipto Frisé / Noce matt

***available wood finishes *Eucalyptus Frisé / Walnut matt*

BATHROOM COLLECTIVE

Dame | Freestanding

- Peso netto: 110 kg
- Volume della cassa:
85x70x135 cm
- Peso lordo: 190 Kg
- Net weight: 110 kg
- Crate volume:
85x70x135 cm
- Gross weight: 190 kg

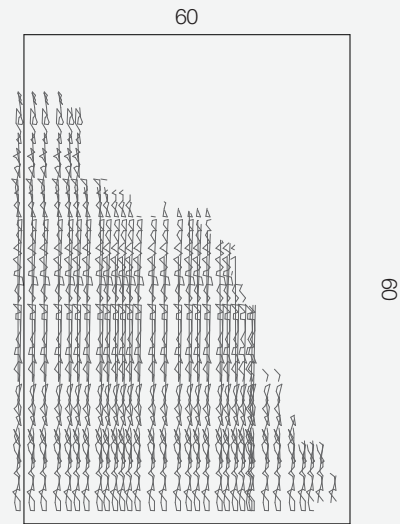
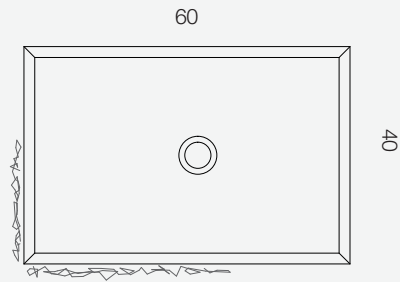

Marmo / Marble

Nero Marquina

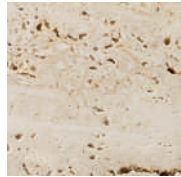

Travertino Paglierino

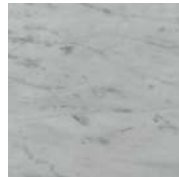

Bianco Carrara

- Peso netto: 21,5 kg
- Volume della cassa: 65x65x45 cm
- Peso lordo: 42 Kg
- Net weight: 21,5 kg
- Crate volume: 65x65x45 cm
- Gross weight: 42 kg

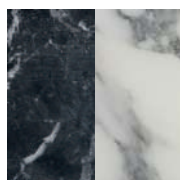
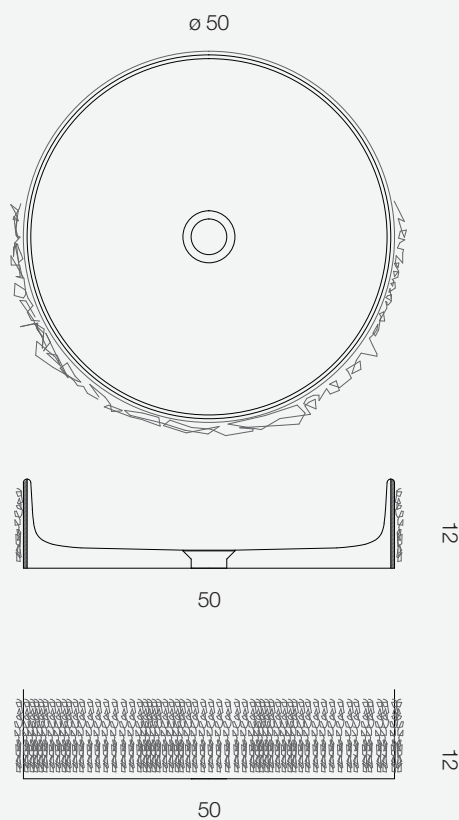

Nero Marquina +
Calacatta Carrara

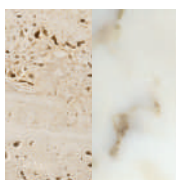

Travertino Paglierino
+ Bianco Del Re

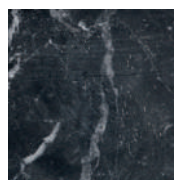

Nero Marquina

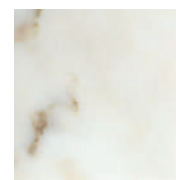

Bianco Del Re

Marmo / Marble

- Peso netto: 17,5 kg
- Volume della cassa: 65x65x45 cm
- Peso lordo: 38 Kg
- Net weight: 17,5 kg
- Crate volume: 65x65x45 cm
- Gross weight: 38 Kg

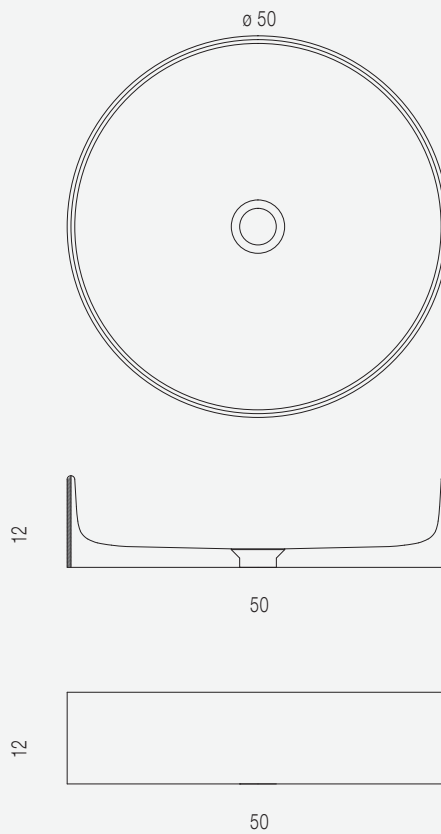

Rosso Lepanto +
Calacatta Carrara



Artik Green +
Calacatta Carrara



Travertino Paglierino
+ Bianco Del Re

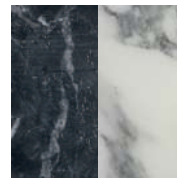

Nero Marquina +
Calacatta Carrara



Grigio St Marie +
Bianco Carrara

Marmo / Marble

- Peso netto: 31,5 kg
- Volume della cassa: 85x75x55 cm
- Peso lordo: 75 Kg
- *Net weight: 31,5 kg*
- *Crate volume: 85x75x55 cm*
- *Gross weight: 75 Kg*

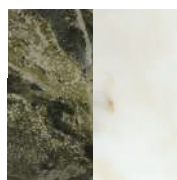
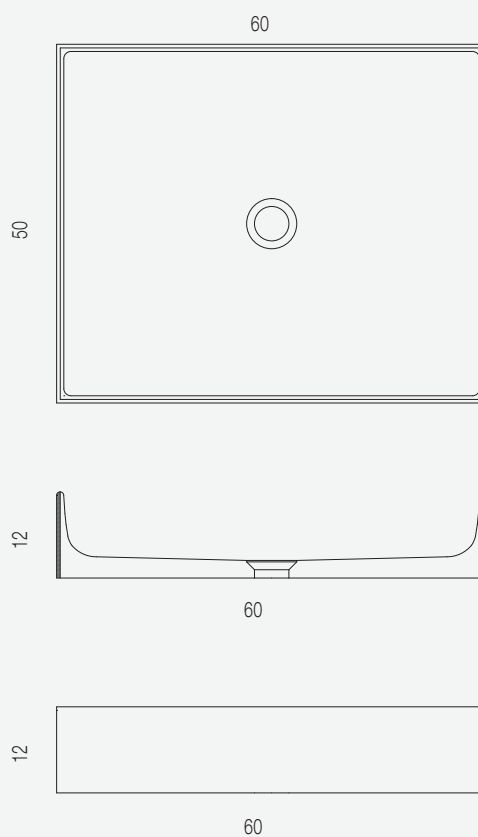

Artik Green +
Bianco Del Re



Verde Alpi +
Artik Green

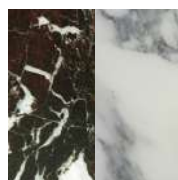

Rosso Lepanto +
Calacatta Carrara



Travertino Paglierino
+ Bianco Del Re

Marmo / Marble

- Lavabo realizzabile in Travertino Titanium su richiesta
- *Washbasin available in Travertino Titanium on request*

BATHROOM COLLECTIVE

- Peso: 133 kg
- Volume della cassa: 70x70x121 cm
- Peso lordo: 203 kg
- Weight: 133 kg
- Volume of the crate: 70x70x121 cm
- Gross weight: 203 kg

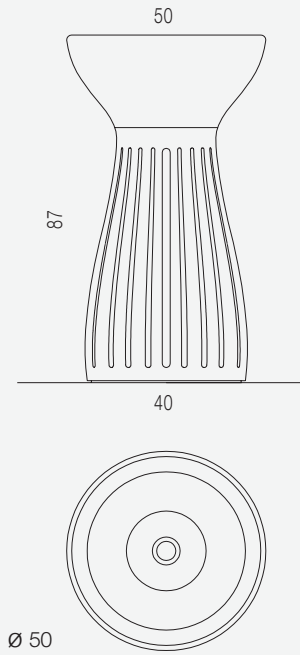

Marmo / Marble

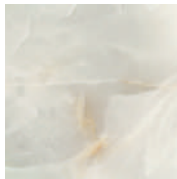

Onice Bianco



Light Sky Onyx

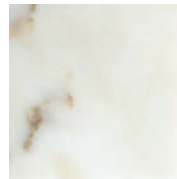

Bianco del Re



Calacatta Carrara



Calacatta Classico

Marmo / Marble

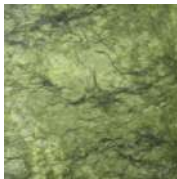

Verde Ming



Nero Portoro



Grigio St. Marie



Persian Grey

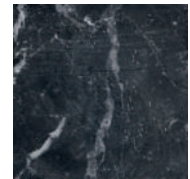

Nero Marquina

Scalanature / Grooves

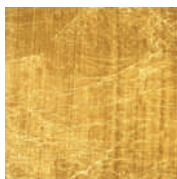

Foglia Oro
Gold

- Peso: 31 kg
- Volume della cassa: 69x68x58 cm
- Peso lordo: 72 kg
- Weight: 31 kg
- Volume of the crate: 69x68x58 cm
- Gross weight: 72 kg

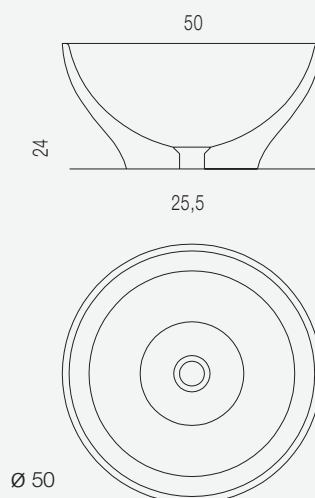

Marmo / Marble

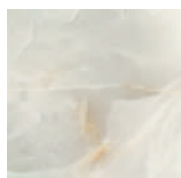

Onice Bianco



Light Sky Onyx

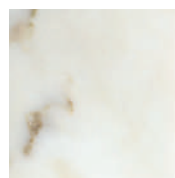

Bianco del Re



Calacatta Carrara



Calacatta Classico

Marmo / Marble

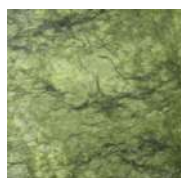

Verde Ming



Nero Portoro



Grigio St. Marie

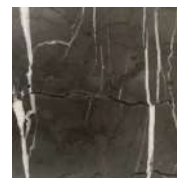

Persian Grey



Nero Marquina

- Peso: 282 kg
- Volume della cassa: 66x66x122 cm
- Peso lordo: 349 kg
- Weight: 282 kg
- Volume of the crate: 66x66x122 cm
- Gross weight: 349 kg

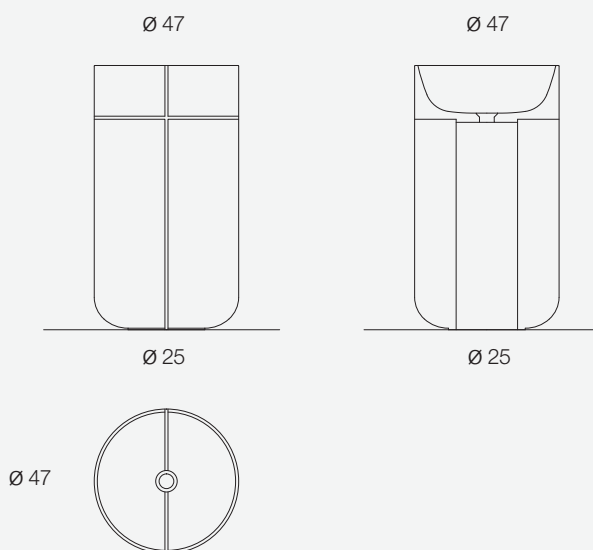

Marmo / Marble

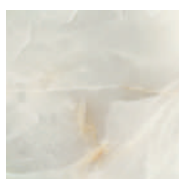

Onice Bianco

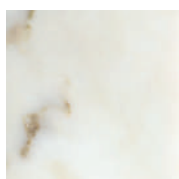

Bianco del Re



Calacatta Carrara



Calacatta Classico



Nero Portoro

Marmo / Marble



Artik Green



Verde Ming

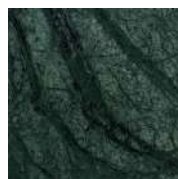

Verde Imperiale



Grigio St. Marie

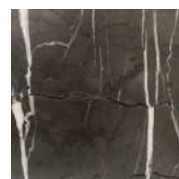

Persian Grey

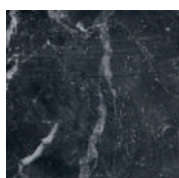

Nero Marquina

- Peso: 34 kg
- Volume della cassa:
66x66x53 cm
- Peso lordo: 71 kg
- Weight: 34 kg
- Volume of the crate:
66x66x53 cm
- Gross weight: 71 kg

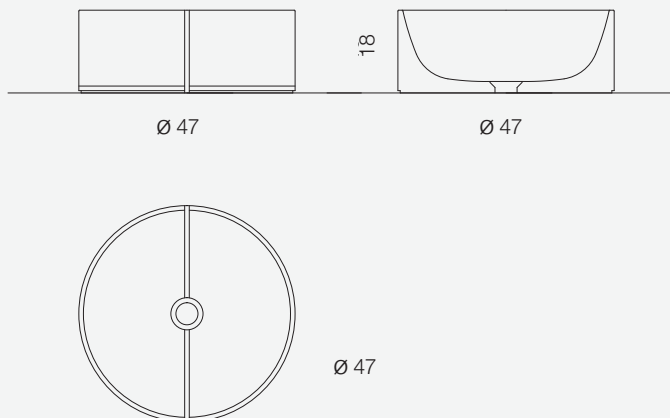

Marmo / Marble

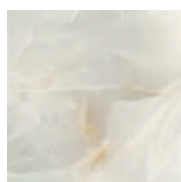

Onice Bianco

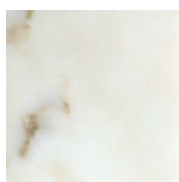

Bianco del Re



Calacatta Carrara



Calacatta Classico



Nero Portoro

Marmo / Marble



Artik Green

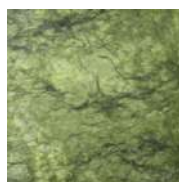

Verde Ming



Verde Imperiale



Grigio St. Marie

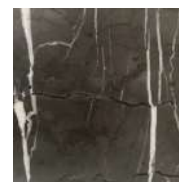

Persian Grey

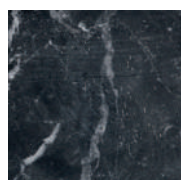

Nero Marquina

- Peso: 158 kg
- Volume della cassa: 69x69x122 cm
- Peso lordo: 228 kg
- Weight: 158 kg
- Volume of the crate: 69x69x122 cm
- Gross weight: 228 kg

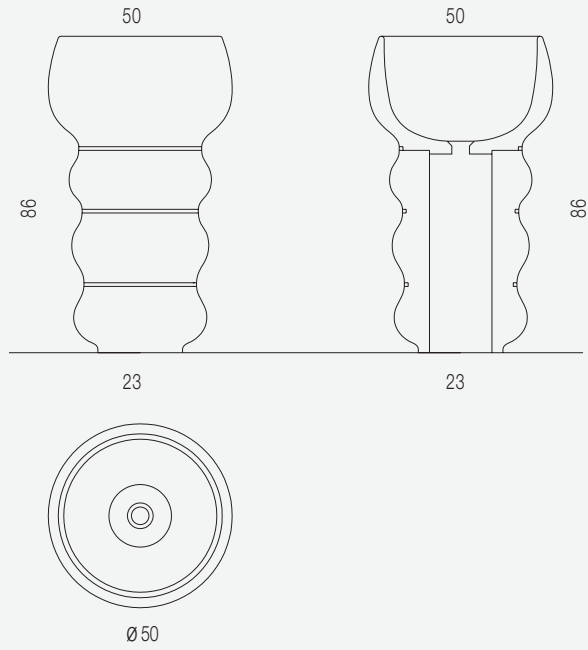

Marmo / Marble

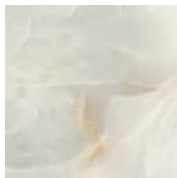

Onice Bianco

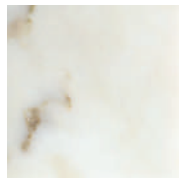

Bianco del Re



Calacatta Carrara



Calacatta Classico



Nero Portoro

Marmo / Marble

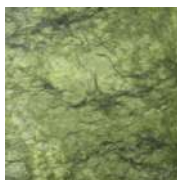

Verde Ming

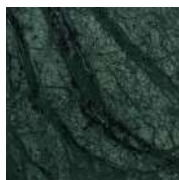

Verde Imperiale



Grigio St. Marie

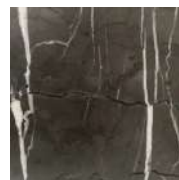

Persian Grey



Nero Marquina

- La combinazione doppio colore è considerata una personalizzazione rispetto alle finiture standard.
 - Double colour combination is considered a customization from the standard finishes.

- Peso: 49 kg
- Volume della cassa:
69x69x66 cm
- Peso lordo: 96 kg
- Weight: 49 kg
- Volume of the crate:
69x69x66 cm
- Gross weight: 96 kg

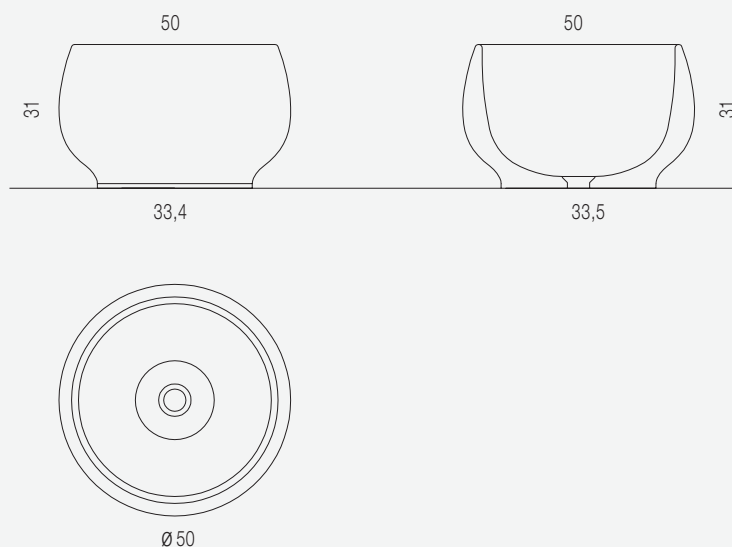

Marmo / Marble

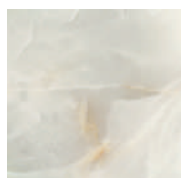

Onice Bianco

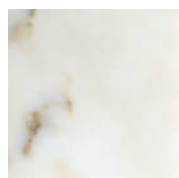

Bianco del Re



Calacatta Carrara



Calacatta Classico



Nero Portoro

Marmo / Marble

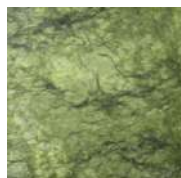

Verde Ming

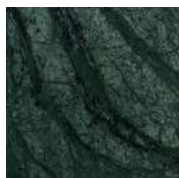

Verde Imperiale



Grigio St. Marie



Persian Grey



Nero Marquina

- Peso netto ciotola: 89 kg
- Volume della cassa colonna: 99x69x105 cm
- Peso lordo: 172 kg
- Fornito in 2 pezzi
- Net weight bowl: 89 kg
- Crate volume column: 99x69x105 cm
- Gross weight: 172 kg
- Supplied in two separate pieces

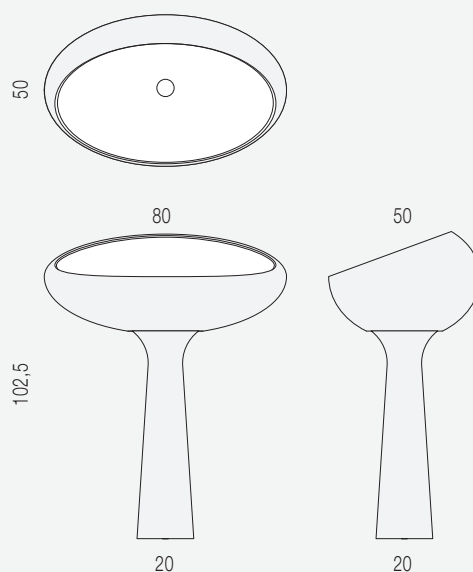

Marmo / Marble

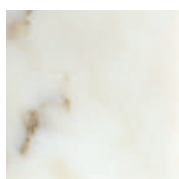

Bianco del Re



Calacatta Carrara



Calacatta Classico



Bianco Carrara



Nero Portoro

Marmo / Marble



Artik Green



Verde Ming



Rosso Francia

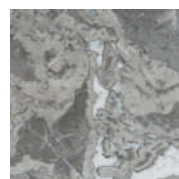

Grigio St. Marie

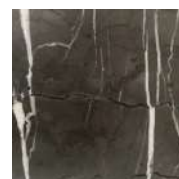

Persian Grey

Marmo / Marble

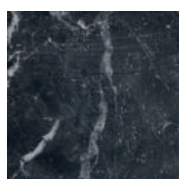

Nero Marquina

Small

- Peso netto: 21 kg
- Volume della cassa: 79x57x60 cm
- Peso lordo: 60 kg
- Predisposizione foro per piletta, diametro 5 cm (piletta a richiesta)
- Net weight: 21 kg
- Crate volume: 79x57x60 cm
- Gross weight: 60 kg
- Drain hole cm 5 diameter (drain on demand)

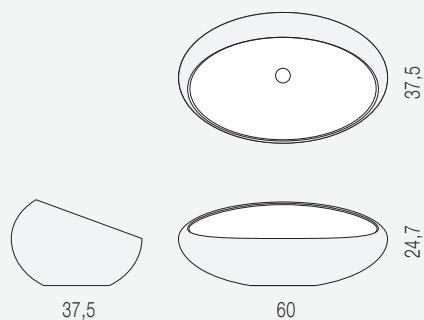

Large

- Peso netto: 58 kg
- Volume della cassa: 99x69x68 cm
- Peso lordo: 116 kg
- Predisposizione foro per piletta, diametro 5 cm (piletta a richiesta)
- Net weight: 58 kg
- Crate volume: 99x69x68 cm
- Gross weight: 116 kg
- Drain hole cm 5 diameter (drain on demand)

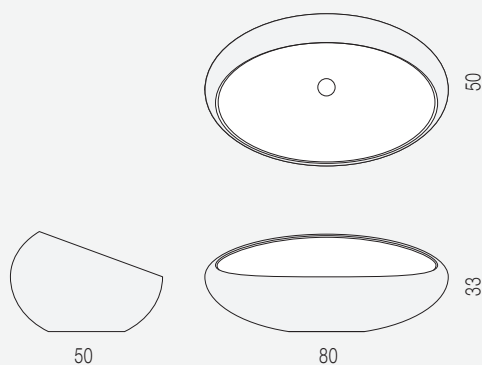

Marmo / Marble

Small
Large

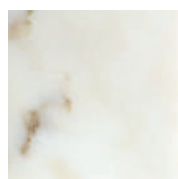

Bianco del Re



Calacatta Carrara



Calacatta Classico



Bianco Carrara



Nero Portoro

Marmo / Marble

Small
Large



Artik Green

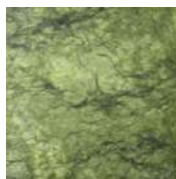

Verde Ming



Rosso Francia



Grigio St. Marie



Persian Grey

Marmo / Marble

Small
Large

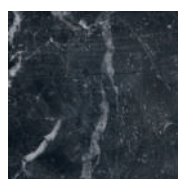

Nero Marquina

BATHROOM COLLECTIVE

- Peso netto ciotola: 57 kg
- Volume della cassa colonna: 104x60x90 cm
- Peso lordo: 126 kg
- Fornito in 2 pezzi
- Predisposizione foro per pileta, diametro 5 cm (pileta a richiesta)
- Net weight bowl: 57 kg
- Net weight column: kg
- Crate volume column: 104x60x90 cm
- Gross weight: 126 kg
- Supplied in two separate pieces
- Drain hole cm 5 diameter (drain on demand)

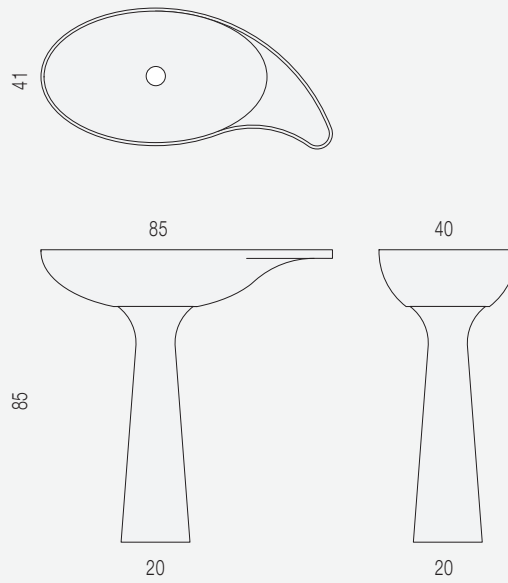

Marmo / Marble



Wooden Onyx



Onice Verde Smeraldo

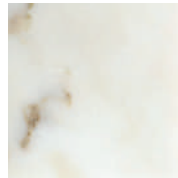

Bianco del Re



Calacatta Carrara



Calacatta Classico

Marmo / Marble



Nero Portoro



Verde Ming

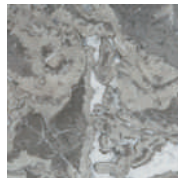

Grigio St. Marie



Persian Grey

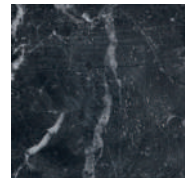

Nero Marquina

- Peso netto: 26 kg
- Volume della cassa:
104x60x52 cm
- Peso lordo: 72 kg
- Predisposizione foro per
piletta, diametro 5 cm
(piletta a richiesta)
- Net weight: 26 kg
- Crate volume:
104x60x52 cm
- Gross weight: 72 kg
- Drain hole cm 5 diameter
(drain on demand)

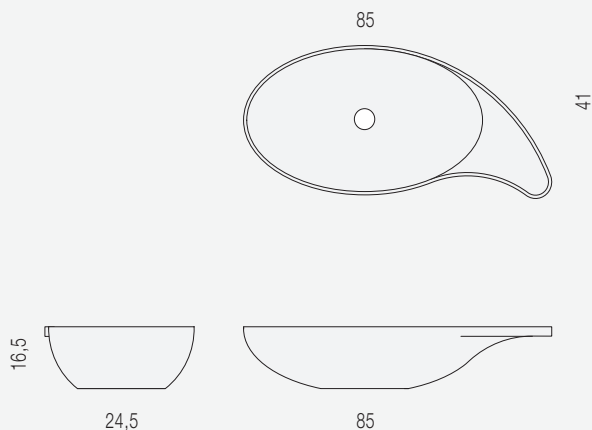

Marmo / Marble



Wooden Onyx



Onice Verde Smeraldo

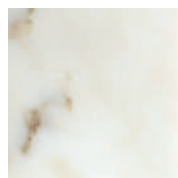

Bianco del Re



Calacatta Carrara



Calacatta Classico

Marmo / Marble



Nero Portoro



Verde Ming

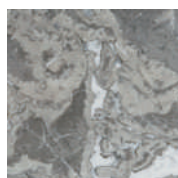

Grigio St. Marie



Persian Grey

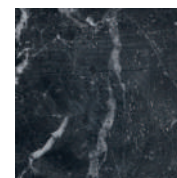

Nero Marquina

Athene

- Peso netto: 74,5 kg
- Volume della cassa:
69X69X119 cm
- Peso lordo: 142,5 kg
- Net weight: 74,5 kg
- Crate volume:
69X69X119 cm
- Gross weight: 142,5 kg

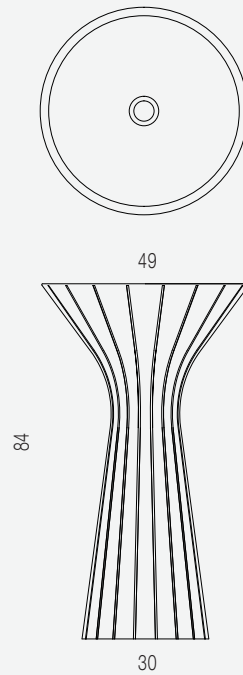

Marmo / Marble

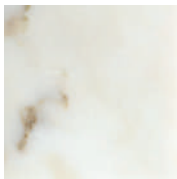

Bianco del Re



Calacatta Carrara



Calacatta Classico



Verde Ming



Grigio St. Marie

Marmo / Marble



Persian Grey

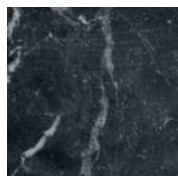

Nero Marquina

BATHROOM COLLECTIVE

La base in marmo avrà un foro per l'inserimento del tubo di scarico.

The marble base is perforated for the insertion of the drain pipe.

- Peso netto: 67 kg
- Volume della cassa: 98x73x110 cm
- Peso lordo: 154 Kg
- Fornito in due pezzi
- Predisposizione foro per piletta, diametro 5 cm (piletta a richiesta)

- *Net weight: 67 kg*
- *Crate volume: 98x73x110 cm*
- *Gross weight: 154 kg*
- *Supplied in two separate pieces*
- *Drain hole cm 5 diameter (drain on demand)*

Dry - Wall Drain

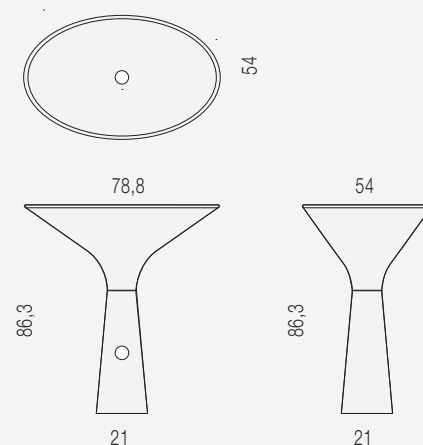

- Peso netto: 67 kg
- Volume della cassa: 98x73x110 cm
- Peso lordo: 154 Kg
- Fornito in due pezzi
- Predisposizione foro per piletta, diametro 5 cm (piletta a richiesta)

- *Net weight: 67 kg*
- *Crate volume: 98x73x110 cm*
- *Gross weight: 154 kg*
- *Supplied in two separate pieces*
- *Drain hole cm 5 diameter (drain on demand)*

Dry - Floor Drain

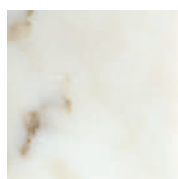
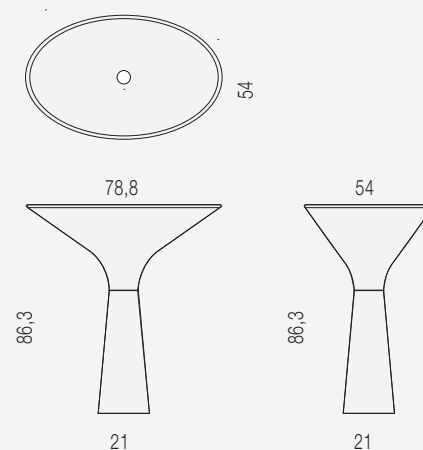

Bianco del Re



Calacatta Carrara



Calacatta Classico



Bianco Carrara

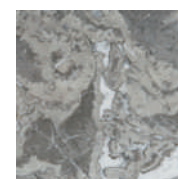

Grigio St. Marie

Marmo / Marble

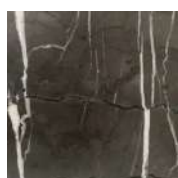

Persian Grey

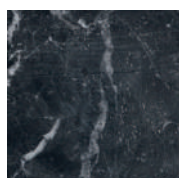

Nero Marquina



Artik Green

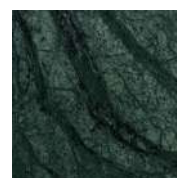

Verde Imperiale

Marmo / Marble

Bento

- Peso bowl: 63,5 kg
- Volume cassa bowl: 124x69x72cm
- Peso lordo: 126,5 Kg
- Predisposizione foro per piletta, diametro 5 cm (piletta a richiesta)
- Bowl weight: 63,5 kg
- Crate volume: 124x69x72cm
- Gross weight: 126,5 kg
- Drain hole cm 5 diameter (drain on demand)

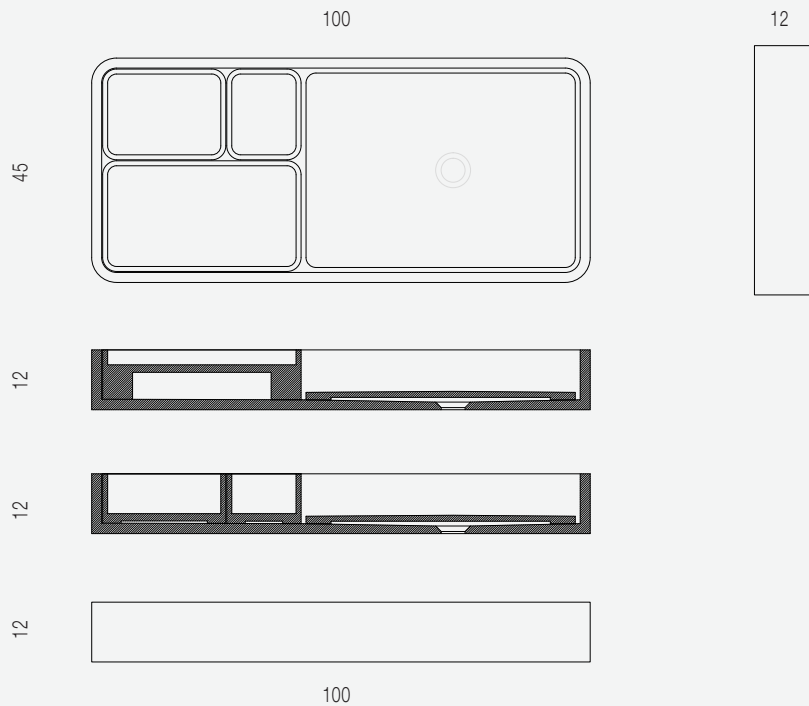

Marmo / Marble



Bianco del Re



Calacatta Classico



Calacatta Carrara



Bianco Carrara

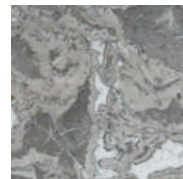

Grigio St. Marie

Marmo / Marble



Calacatta Viola



Persian Grey

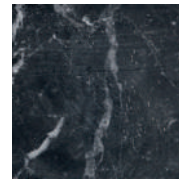

Nero Marquina

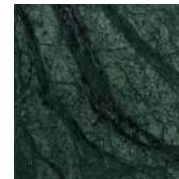

Verde Imperiale

- Lavabo realizzabile in Travertino Titanium su richiesta
- Washbasin available in Travertino Titanium on request

BATHROOM COLLECTIVE

60 cm

- Peso netto: 39,5 kg
- Volume della cassa: 79x61x62 cm
- Peso lordo: 83,5 kg
- Predisposizione foro per piletta, diametro 5 cm (piletta a richiesta)
- *Net weight: 39,5 kg*
- *Crate volume: 79x61x62 cm*
- *Gross weight: 83,5 kg*
- *Drain hole cm 5 diameter (drain on demand)*

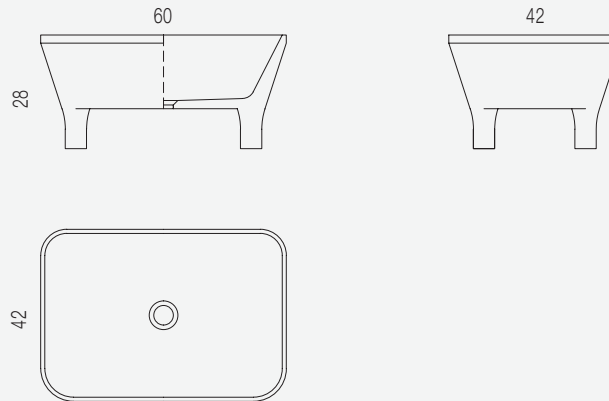

80 cm

- Peso netto: 52,5 kg
- Volume della cassa: 99x70x63 cm
- Peso lordo: 108,5 kg
- Predisposizione foro per piletta, diametro 5 cm (piletta a richiesta)
- *Net weight: 52,2 kg*
- *Crate volume: 99x70x63 cm*
- *Gross weight: 108,5 kg*
- *Drain hole cm 5 diameter (drain on demand)*

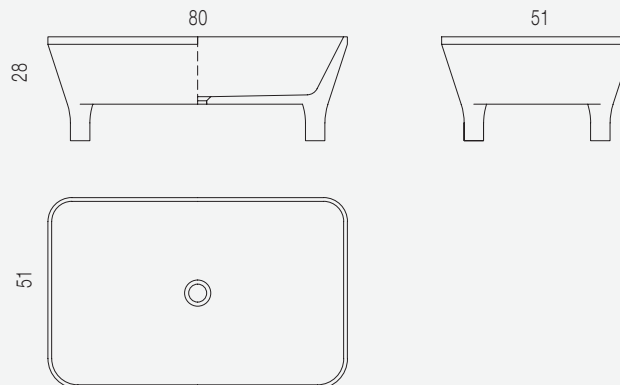

Marmo / Marble

60 cm
80 cm

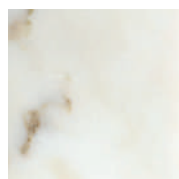

Bianco del Re



Calacatta Carrara



Calacatta Classico

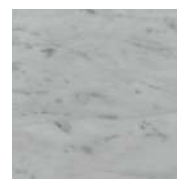

Bianco Carrara

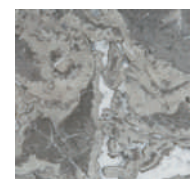

Grigio St. Marie

Marmo / Marble

60 cm
80 cm

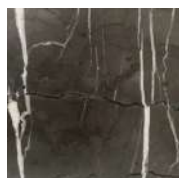

Persian Grey

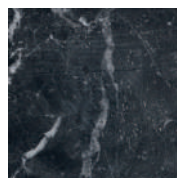

Nero Marquina

Loto 02

60 cm

- Peso netto: 38 kg
- Volume della cassa: 78x68x62 cm
- Peso lordo: 86 kg
- Predisposizione foro per piletta, diametro 5 cm (piletta a richiesta)
- Net weight: 38 kg
- Crate volume: 78x68x62 cm
- Gross weight: 86 kg
- Drain hole cm 5 diameter (drain on demand)

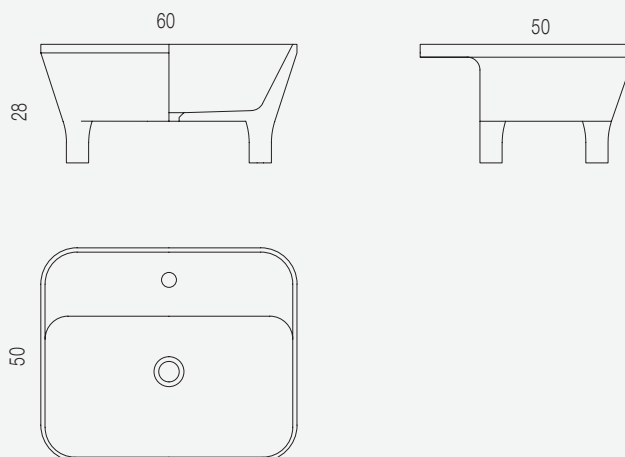

80 cm

- Peso netto: 62,5 kg
- Volume della cassa: 98x77x62 cm
- Peso lordo: 122,5 kg
- Predisposizione foro per piletta, diametro 5 cm (piletta a richiesta)
- Net weight: 62,5 kg
- Crate volume: 98x77x62 cm
- Gross weight: 122,5 kg
- Drain hole cm 5 diameter (drain on demand)

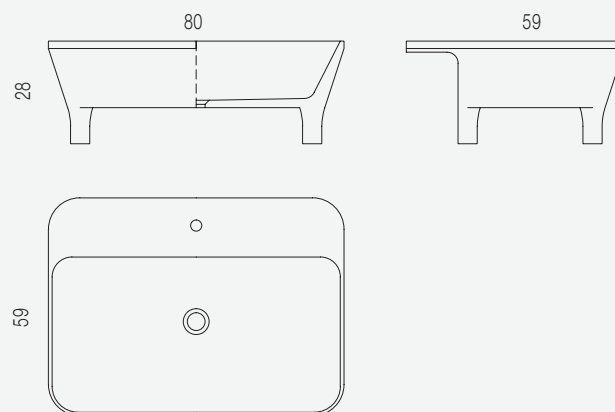

Marmo / Marble

60 cm

80 cm

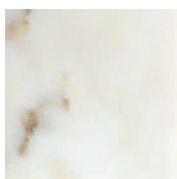

Bianco del Re



Calacatta Carrara



Calacatta Classico



Bianco Carrara



Grigio St. Marie

Marmo / Marble

60 cm

80 cm

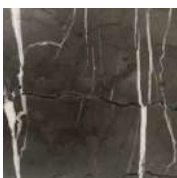

Persian Grey

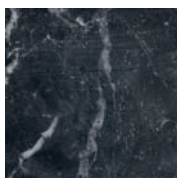

Nero Marquina

Loto Easel Small

- Peso netto: 5,5 kg
- Volume della cassa: 70x58x49 cm
- Peso lordo: 26,5 Kg
- Net weight: 5,5 kg
- Crate volume: 70x58x49 cm
- Gross weight: 26,5 kg

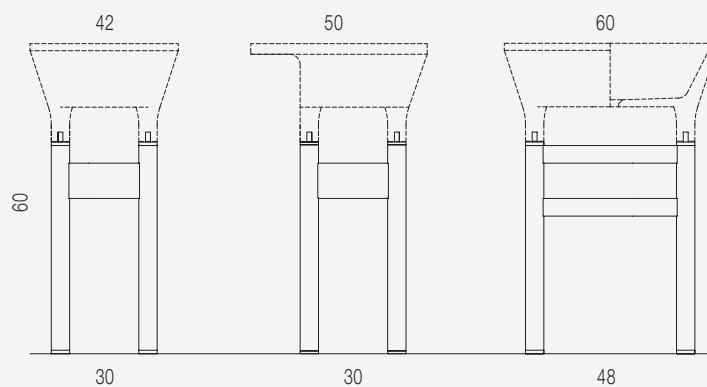

Loto Easel

- Peso netto: 7 kg
- Volume della cassa: 78x70x49 cm
- Peso lordo: 32 Kg
- Net weight: 7 kg
- Crate volume: 78x70x49 cm
- Gross weight: 32 kg

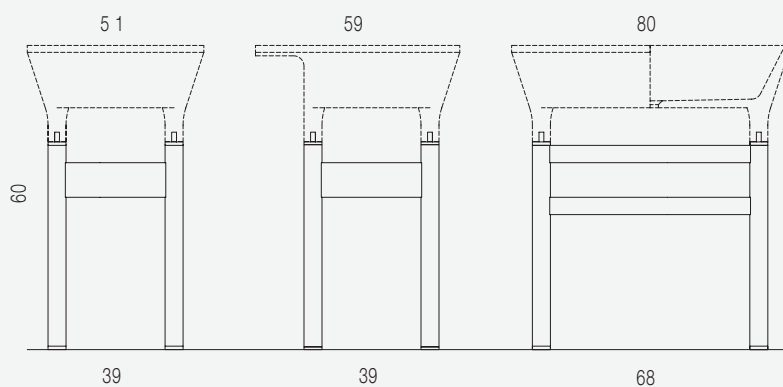

Larice spazzolato
Brushed larch



Larice Bianco
White Larch



Larice Invecchiato
Aged Larch

Larice Grigio
Grey Larch

- Peso: 65 kg
- Volume della cassa: 92x69x50 cm
- Peso lordo: 110 kg
- Predisposizione foro per piletta, diametro 5 cm (piletta a richiesta)
- Weight: 65 kg
- Volume of the crate: 92x69x50 cm
- Gross weight: 110 kg
- Drain hole cm 5 diameter (drain on demand)

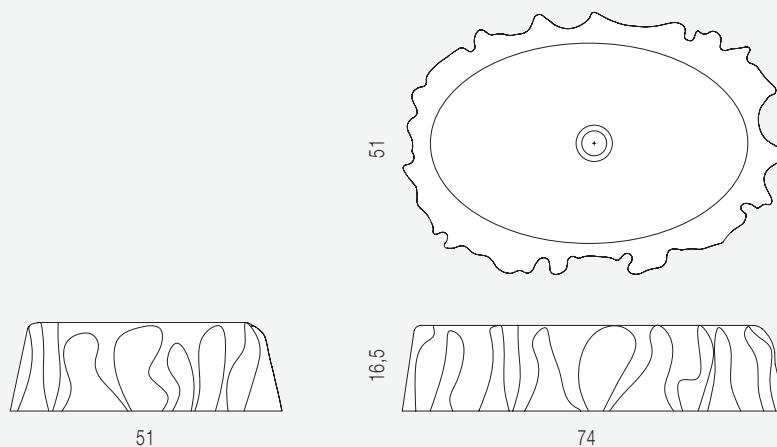

Marmo / Marble

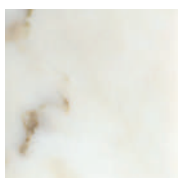

Bianco del Re



Calacatta Carrara



Bianco Carrara

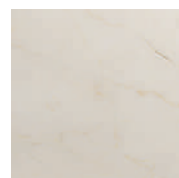

Crema Marfil

Marmo / Marble

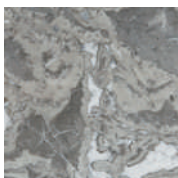

Grigio St. Marie



Nero Marquina

- Peso: 19 kg
- Volume della cassa: 63x63x50 cm
- Peso lordo: 54 Kg
- Predisposizione foro per piletta, diametro 5 cm (piletta a richiesta)
- Weight: 19 kg
- Volume of the crate: 63x63x50 cm
- Gross weight: 54 kg
- Drain hole cm 5 diameter (drain on demand)

Medium

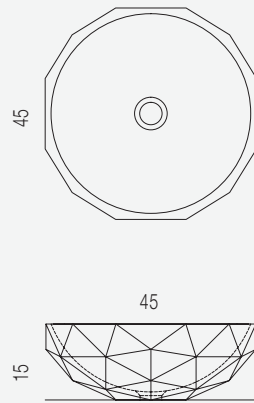

Inclined Medium

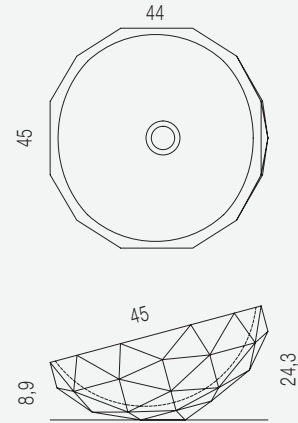

- Peso: 27 kg
- Volume della cassa: 68x68x52 cm
- Peso lordo: 66 Kg
- Predisposizione foro per piletta, diametro 5 cm (piletta a richiesta)
- Weight: 27 kg
- Volume of the crate: 68x68x52 cm
- Gross weight: 66 kg
- Drain hole cm 5 diameter (drain on demand)

Large

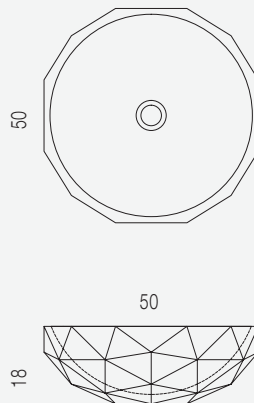

Inclined Large

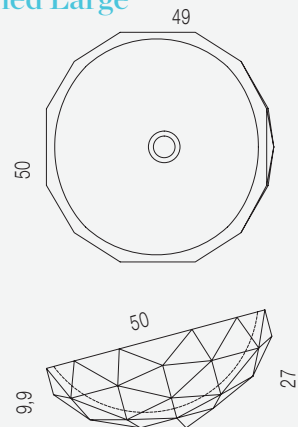

Marmo / Marble

Medium / Inclined Medium
Large / Inclined Large

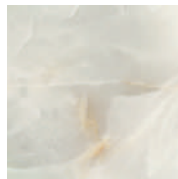

Onice Bianco



Onice Rosa



Light Sky Onyx

Marmo / Marble

Medium / Inclined Medium
Large / Inclined Large

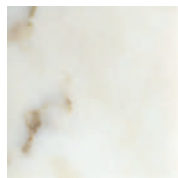

Bianco del Re



Calacatta Carrara



Bianco Carrara



Persian Grey



Nero Marquina

- Peso bowl: 20 kg
- Volume della cassa: 84x74x41 cm
- Peso lordo: 45 Kg
- Predisposizione foro per pileta, diametro 5 cm (pileta a richiesta)
- Bowl weight: 20 kg
- Crate volume: 84x74x41 cm
- Gross weight: 45 kg
- Drain hole cm 5 diameter (drain on demand)

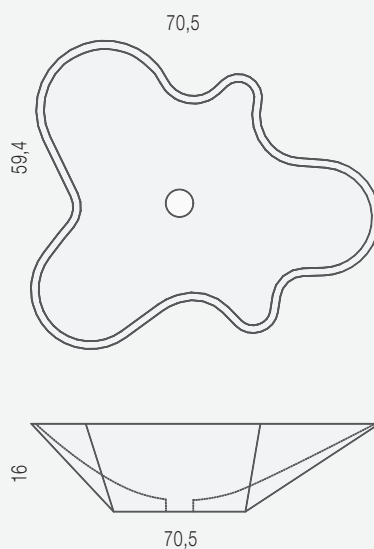

Marmo / Marble

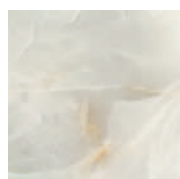

Onice Bianco



Onice Rosa

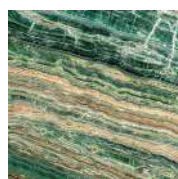

Onice Verde Smeraldo



Light Sky Onyx

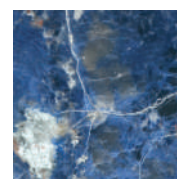

Sodalite Blu

Marmo / Marble

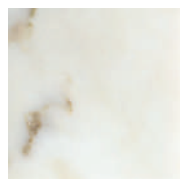

Bianco del Re



Calacatta Carrara

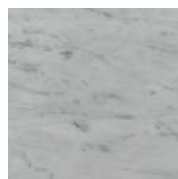

Bianco Carrara



Artik Green



Verde Ming

Marmo / Marble

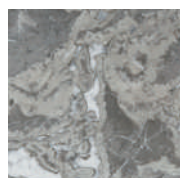

Grigio St. Marie

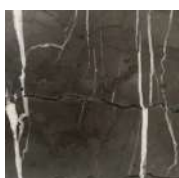

Persian Grey

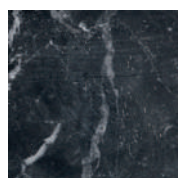

Nero Marquina

SMALL 41,5 CM

- Peso netto: 14 Kg
- Volume cassa: 55x55x42 cm
- Peso lordo: 30 Kg

SMALL CM 41,5

- Net weight: 14 kg
- Crate volume: 55x55x42 cm
- Gross weight: 30 kg

BIG 50 CM

- Peso netto: 22 kg
- Volume cassa: 63x63x42 cm
- Peso lordo: 41 Kg

BIG CM 50

- Net weigh: 22 kg
- Crate volume: 63x63x42 cm
- Gross weight: 41 kg

Predisposizione foro per piletta, diametro 5 cm (piletta a richiesta)

Drain hole cm 5 diameter (drain on demand)

41,5 Bowl

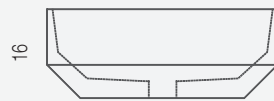

41,5

50 Bowl

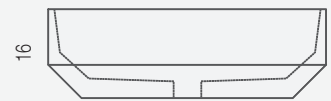

50

Marmo / Marble

Ciotola 41,5 / 41,5 bowl

Ciotola 50 / 50 bowl

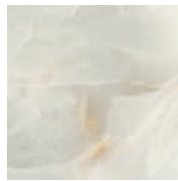

Onice Bianco

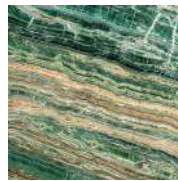

Onice Verde Smeraldo



Light Sky Onyx

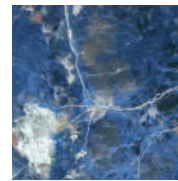

Sodalite Blu

Marmo / Marble

Ciotola 41,5 / 41,5 bowl

Ciotola 50 / 50 bowl

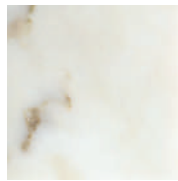

Bianco del Re



Calacatta Carrara

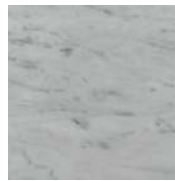

Bianco Carrara



Artik Green

Marmo / Marble

Ciotola 41,5 / 41,5 bowl

Ciotola 50 / 50 bowl



Verde Ming

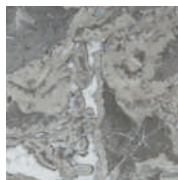

Grigio St. Marie



Persian Grey

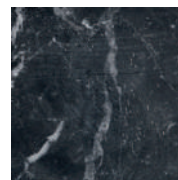

Nero Marquina

Bowl n° 3 | Nabhi Collection

SMALL 41,5 CM

- Peso netto: 13 kg
- Volume cassa: 55x55x42 cm
- Peso lordo: 29 Kg

SMALL CM 41,5

- Net weight 13 kg
- Crate volume: 55x55x42 cm
- Gross weight: 29 kg

BIG 50 CM

- Peso: 22 kg
- Volume cassa: 63x63x42 cm
- Peso lordo: 41 Kg

BIG CM 50

- Weight: 22 kg
- Crate volume: 63x63x42 cm
- Gross weight: 41 kg

Predisposizione foro per piletta, diametro 5 cm (piletta a richiesta)

Drain hole cm 5 diameter
(drain on demand)

41,5 Bowl

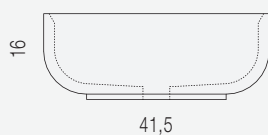
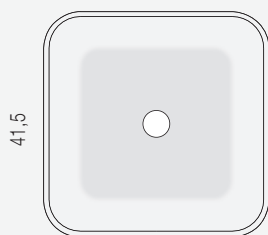

50 Bowl

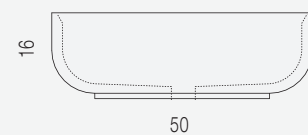
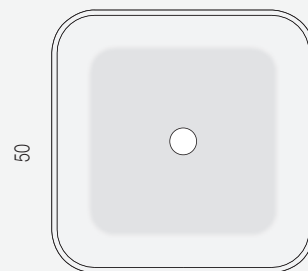

Marmo / Marble

Ciotola 41,5 / 41,5 bowl

Ciotola 50 / 50 bowl

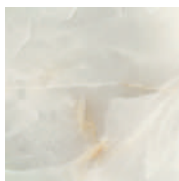

Onice Bianco

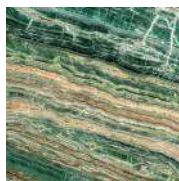

Onice Verde Smeraldo



Light Sky Onyx

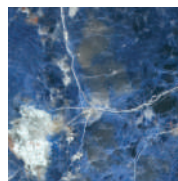

Sodalite Blu

Marmo / Marble

Ciotola 41,5 / 41,5 bowl

Ciotola 50 / 50 bowl

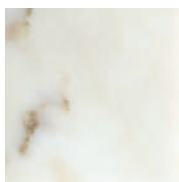

Bianco del Re



Calacatta Carrara



Bianco Carrara



Artik Green

Marmo / Marble

Ciotola 41,5 / 41,5 bowl

Ciotola 50 / 50 bowl

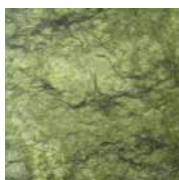

Verde Ming

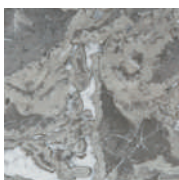

Grigio St. Marie

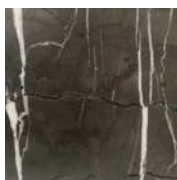

Persian Grey

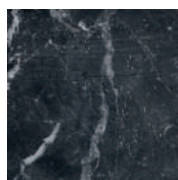

Nero Marquina

SMALL 41,5 CM

- Peso netto: 12 Kg
- Volume cassa: 55x55x42 cm
- Peso lordo: 28 Kg

SMALL 41,5 CM

- Net weight: 12 kg
- Crate volume: 55x55x42 cm
- Gross weight: 28 kg

BIG 50 CM

- Peso: 18 kg
- Volume cassa: 63x63x42 cm
- Peso lordo: 37 Kg

BIG 50 CM

- Net weight: 18 kg
- Crate volume: 63x63x42 cm
- Gross weight: 37 kg

Predisposizione foro per piletta, diametro 5 cm (piletta a richiesta)

Drain hole 5 cm diameter (drain on demand)

41,5 Bowl

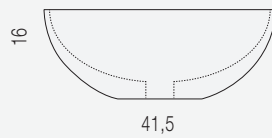

50 Bowl

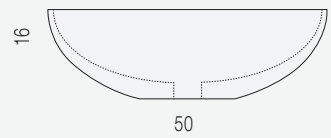

Marmo / Marble

Ciotola 41,5 / 41,5 bowl

Ciotola 50 / 50 bowl

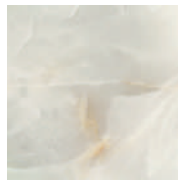

Onice Bianco

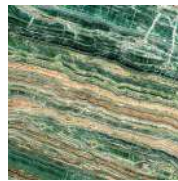

Onice Verde Smeraldo



Light Sky Onyx

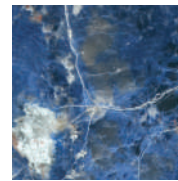

Sodalite Blu

Marmo / Marble

Ciotola 41,5 / 41,5 bowl

Ciotola 50 / 50 bowl

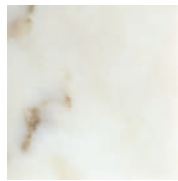

Bianco del Re



Calacatta Carrara

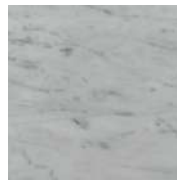

Bianco Carrara



Artik Green

Marmo / Marble

Ciotola 41,5 / 41,5 bowl

Ciotola 50 / 50 bowl



Verde Ming



Grigio St. Marie



Persian Grey

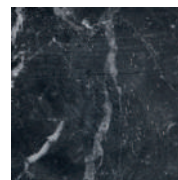

Nero Marquina

SMALL 41,5 CM

- Peso netto: 14 Kg
- Volume cassa: 55x55x42 cm
- Peso lordo: 30 Kg

SMALL 41,5 CM

- Net weight: 14 kg
- Crate volume: 55x55x42 cm
- Gross weight: 30 kg

BIG 50 CM

- Peso: 27 kg
- Volume cassa: 63x63x42 cm
- Peso lordo: 46 Kg

BIG 19,68

- Net weight: 27 kg
- Crate volume: 63x63x42 cm
- Gross weight: 46 kg

Predisposizione foro per piletta, diametro 5 cm (piletta a richiesta)

Drain hole 1,96 in diameter (drain on demand)

41,5 Bowl

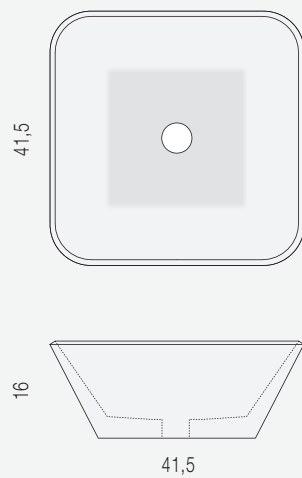

50 Bowl

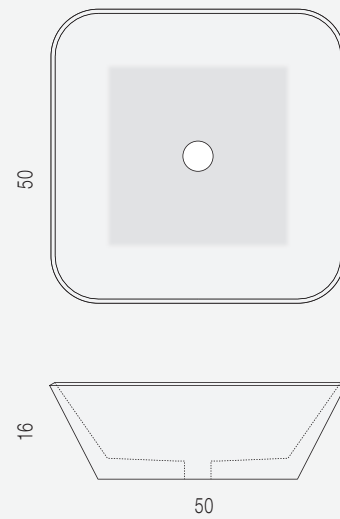

Marmo / Marble

Ciotola 41,5 / 41,5 bowl

Ciotola 50 / 50 bowl

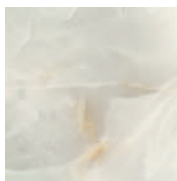

Onice Bianco

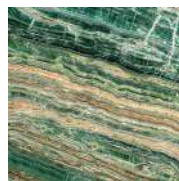

Onice Verde Smeraldo



Light Sky Onyx



Sodalite Blu

Marmo / Marble

Ciotola 41,5 / 41,5 bowl

Ciotola 50 / 50 bowl

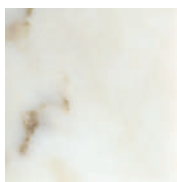

Bianco del Re



Calacatta Carrara

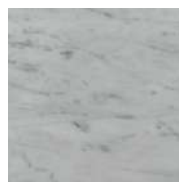

Bianco Carrara



Artik Green

Marmo / Marble

Ciotola 41,5 / 41,5 bowl

Ciotola 50 / 50 bowl

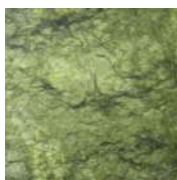

Verde Ming

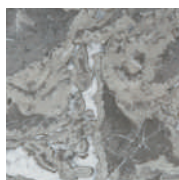

Grigio St. Marie

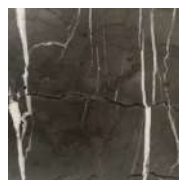

Persian Grey

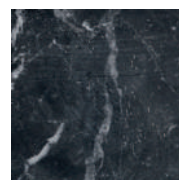

Nero Marquina

- Peso netto: 27 Kg
- Volume cassa bowl: 78x54x42 cm
- Peso lordo: 46 Kg
- Predisposizione foro per piletta, diametro 5 cm (piletta a richiesta)
- Net weight: 27 kg
- Crate volume: 78x54x42 cm
- Gross weight: 46 kg
- Drain hole 5 cm diameter (drain on demand)

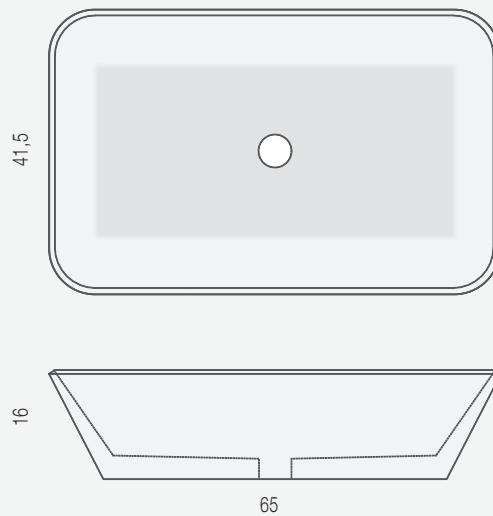

Marmo / Marble

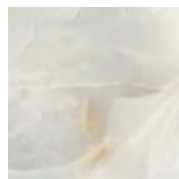

Onice Bianco

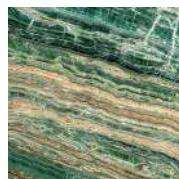

Onice Verde Smeraldo



Light Sky Onyx



Sodalite Blu

Marmo / Marble

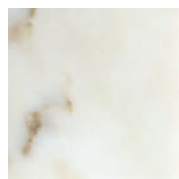

Bianco del Re



Calacatta Carrara



Bianco Carrara



Artik Green

Marmo / Marble



Verde Ming

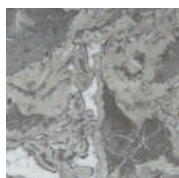

Grigio St. Marie

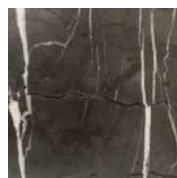

Persian Grey

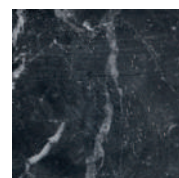

Nero Marquina

- Peso netto: 26 Kg
- Volume cassa bowl: 78x54x42 cm
- Peso lordo: 45 Kg
- Predisposizione foro per pileta, diametro 5 cm (pileta a richiesta)
- Net weight: 26 kg
- Crate volume: 78x54x42 cm
- Gross weight: 45 kg
- Drain hole 5 cm in diameter (drain on demand)

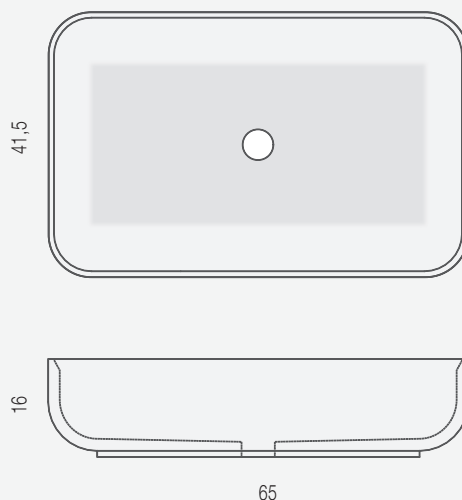

Marmo / Marble

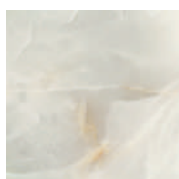

Onice Bianco



Onice Verde Smeraldo



Light Sky Onyx

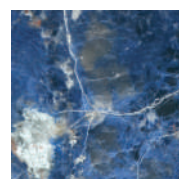

Sodalite Blu

Marmo / Marble

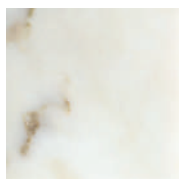

Bianco del Re



Calacatta Carrara

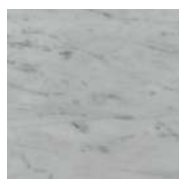

Bianco Carrara



Artik Green

Marmo / Marble

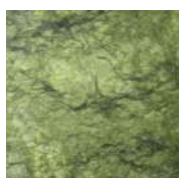

Verde Ming



Grigio St. Marie

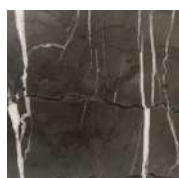

Persian Grey

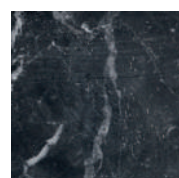

Nero Marquina

- Peso netto: 22 Kg
- Volume cassa bowl: 78x54x42 cm
- Peso lordo: 41 Kg
- Predisposizione foro per piletta, diametro 5 cm (piletta a richiesta)
- Net weight: 22 kg
- Crate volume: 78x54x42 cm
- Gross weight: 41 kg
- Drain hole 5 cm diameter (drain on demand)

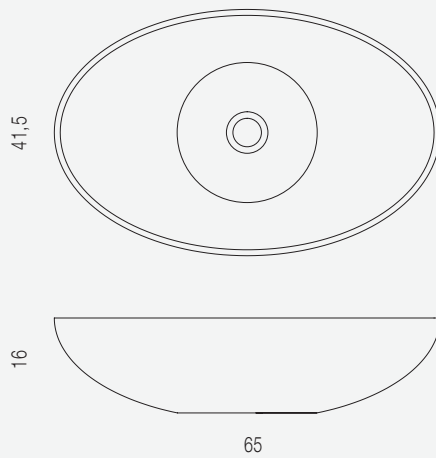

Marmo / Marble

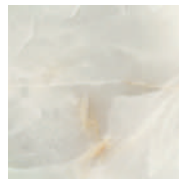

Onice Bianco

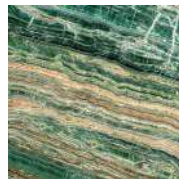

Onice Verde Smeraldo



Light Sky Onyx



Sodalite Blu

Marmo / Marble

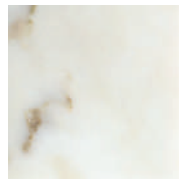

Bianco del Re



Calacatta Carrara



Bianco Carrara



Artik Green

Marmo / Marble



Verde Ming

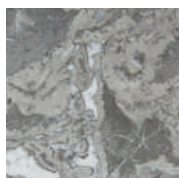

Grigio St. Marie

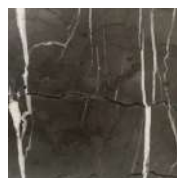

Persian Grey

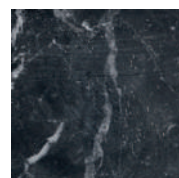

Nero Marquina

Piletta | Drain

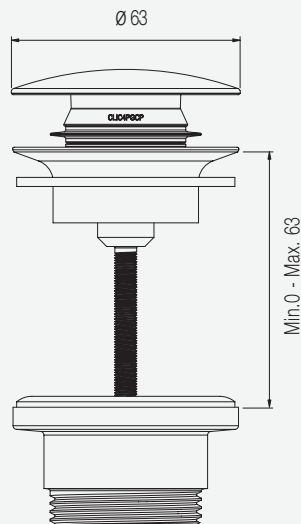

Piletta / Drain

Piletta click clack in finitura cromata
su richiesta a
*Click Clack drain provided in chrome
finish on demand*



Piletta click clack in finitura oro bronzato
satinato su richiesta a
*Click Clack drain provided in gold bronze
metal finish, satin on demand*



Piletta Marmo / Marble Drain

Piletta click clack in finitura cromata con rivestimento in marmo a (logo
Kreoo inciso a laser compreso, salvo vostra indicazione).
*Click clack drain in chrome finish with cover in marble
(Kreoo logo etched included, unless different indications).*

Le pilette fornite sono compatibili con tutti i fori di scarico della nostra collezione bagno.
The click clack drains provided fit all the drain holes of our bathroom collection products.

BATHROOM COLLECTIVE



Shades

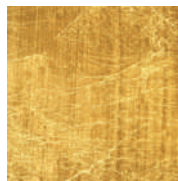

Foglia Oro
Gold



Foglia Argento
Silver



Colore Ral
Ral Color

- Finitura RAL fornita lucida
- Shade è applicabile a tutti i modelli di ciotole proposte nel catalogo
- RAL color finish is provided glossy polished
- Shade can be applied on all the shapes proposed in our catalogue

BATHROOM COLLECTIVE

Trays

SMALL

- Peso netto: 19 kg
- Volume della cassa: 97x60x79 cm
- Peso lordo: 63 Kg
- Spessore: 3 cm

- Net weight: 19 kg
- Volume of the crate: 97x60x79 cm
- Gross weight: 63 kg
- Thickness: 3 cm

MEDIUM

- Peso netto: 27 kg
- Volume della cassa: 112x60x79 cm
- Peso lordo: 81 Kg
- Spessore: 3 cm

- Net weight: 27 kg
- Volume of the crate: 112x60x79 cm
- Gross weight: 81 kg
- Thickness: 3 cm

BIG

- Peso netto: 31,5 kg
- Volume della cassa: 137x60x79 cm
- Peso lordo: 87,5 Kg
- Spessore: 3 cm

- Net weight: 31,5 kg
- Volume of the crate: 137x60x79 cm
- Gross weight: 87,5 kg
- Thickness: 3 cm

ROUND

- Peso netto: 12 kg
- Volume della cassa: 77x60x84 cm
- Peso lordo: 52 Kg
- Spessore: 3 cm

- Net weight: 12 kg
- Volume of the crate: 77x60x84 cm
- Gross weight: 52 kg
- Thickness: 3 cm

Small Tray

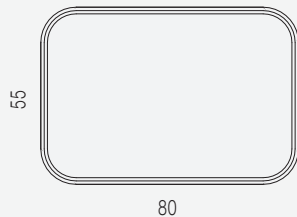

Medium Tray



Big Tray

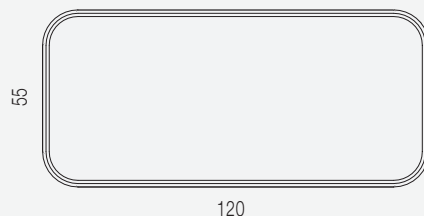

Round Tray

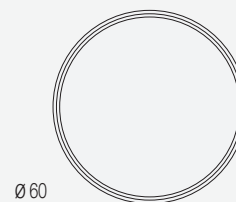

Marmo / Marble

- Small Tray
- Medium Tray
- Big Tray
- Round Tray

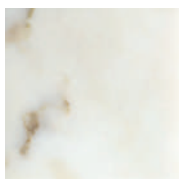

Bianco del Re



Calacatta Carrara

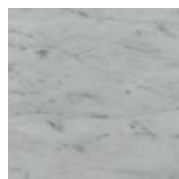

Bianco Carrara



Artik Green



Verde Ming

Marmo / Marble

- Small Tray
- Medium Tray
- Big Tray
- Round Tray

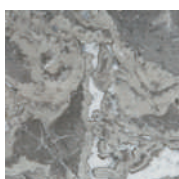

Grigio St. Marie

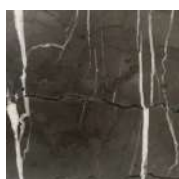

Persian Grey

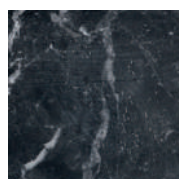

Nero Marquina

BATHROOM COLLECTIVE

SMALL

- Peso netto: 17,5 Kg
- Volume della cassa:
112x60x85 cm
- Peso lordo: 50,5 Kg
- Net weight: 17,5 kg
- Crate volume:
112x60x85 cm
- Gross weight: 50,5 kg

MEDIUM

- Peso netto: 21 Kg
- Volume della cassa:
132x60x85 cm
- Peso lordo: 57 Kg
- Net weight: 21 kg
- Crate volume:
132x60x85 cm
- Gross weight: 57 kg

LARGE

- Peso netto: 42,5 Kg
- Volume della cassa:
252x60x85 cm
- Peso lordo: 108,5 Kg
- Net weight: 42,5 kg
- Crate volume:
252x60x85 cm
- Gross weight: 108,5 kg

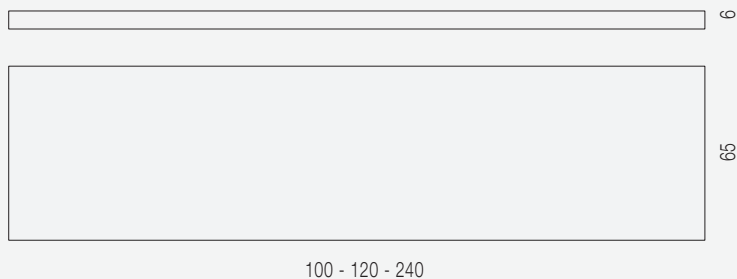

Legno / Wood

100 x 65 cm

120 x 65 cm

240 x 65 cm



Larice Bianco
White Larch



Larice Invecchiato
Aged Larch



Noce Matt
Walnut Matt

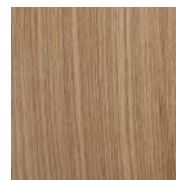

Rovere Naturale
Natural Oak

Linear

LINEAR SINGLE:

Modello sospeso 64 cm:

- Peso netto: 45,5 Kg
- Volume cassa: 92x84x77 cm
- Peso lordo: 123,5 Kg

Wall-hung 64 cm:

- Net weight 45,5 kg
- Crate volume: 92x84x77 cm
- Gross weight: 123,5 kg

Single

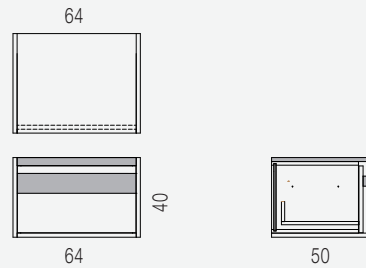

LINEAR DOUBLE:

Modello sospeso 124 cm:

- Peso netto: 89 kg
- Volume cassa: 162x80x76 cm
- Peso lordo: 197 Kg

Wall-hung 124 cm:

- Net weight: 89 kg
- Crate volume: 162x80x76 cm
- Gross weight: 197 kg

Double

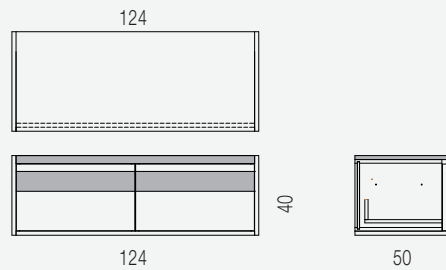

Top e maniglie Top and handle

Marmo / Marble



Calacatta Carrara

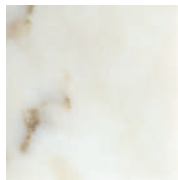

Bianco del Re

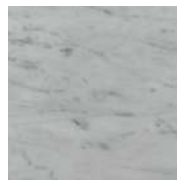

Bianco Carrara



Grigio St. Marie

Marmo / Marble



Persian Grey



Travertino Titanium

Legno / Wood



Noce Matt
Walnut Matt



Larice Bianco
White Larch



Eucalipto Frisè
Eucalyptus Frisè

Single

Double

- Disponibile in versione da appoggio - prezzo su richiesta
- Freestanding available upon request

BATHROOM COLLECTIVE

- Peso netto: 6 kg
- Volume della cassa:
80x65x90 cm
- Peso lordo: 43 Kg
- Net weight: 6 kg
- Volume of the crate:
80x65x90 cm
- Gross weight: 43 kg

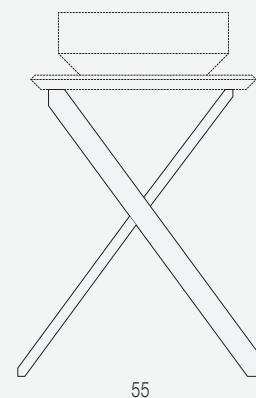
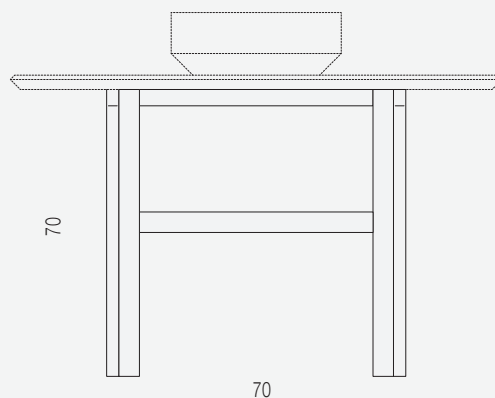

Larice spazzolato
Brushed larch



Larice Bianco
White Larch



Larice Invecchiato
Aged Larch

Larice Grigio
Grey Larch

Kato | Easel

- Peso netto: 25 Kg
- Volume della cassa:
91x66x90 cm
- Peso lordo: 65 Kg

- Net weight: 25 kg
- Crate volume:
91x66x90 cm
- Gross weight: 65 kg

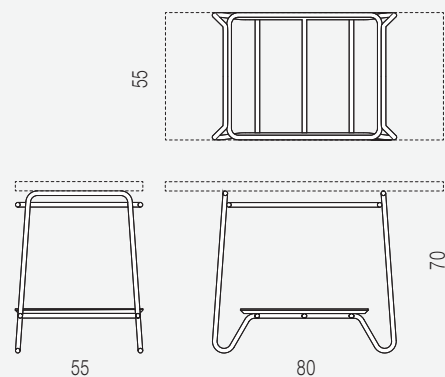
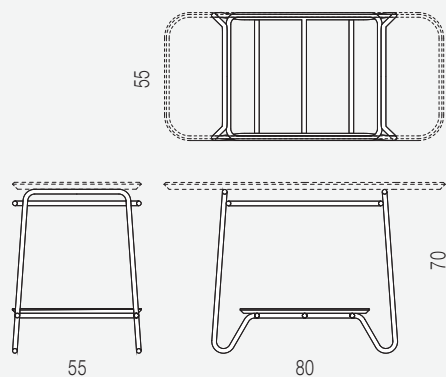

Metal / Metal

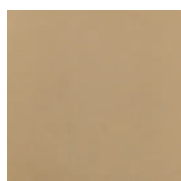

Bronzo Oro
Gold Bronze



Bronzo Rosa
Pink Bronze

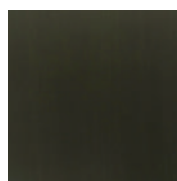

Bronzo Scuro
Dark Bronze

- Peso netto Marble Tray: 31,5 Kg
- Volume della cassa: 137x60x79 cm
- Peso lordo: 87,5 Kg

- Net weight Marble Tray: 31,5 kg
- Crate volume: 137x60x79 cm
- Gross weight: 87,5 kg

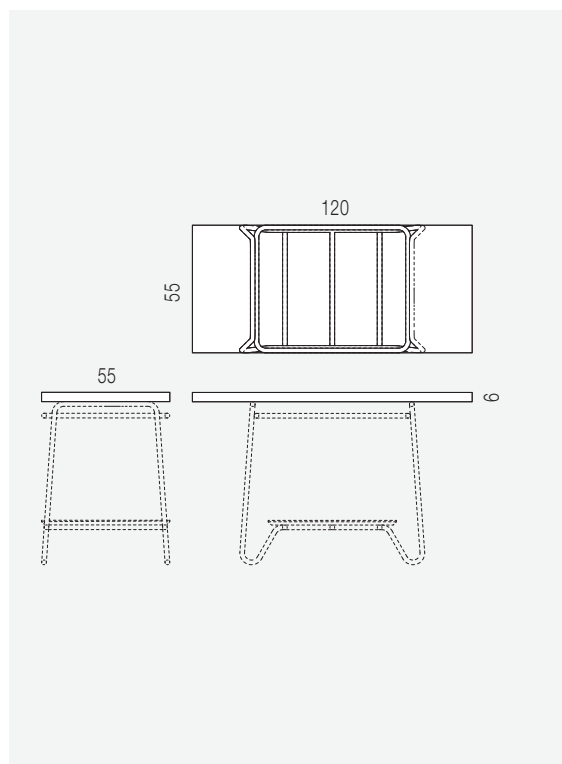
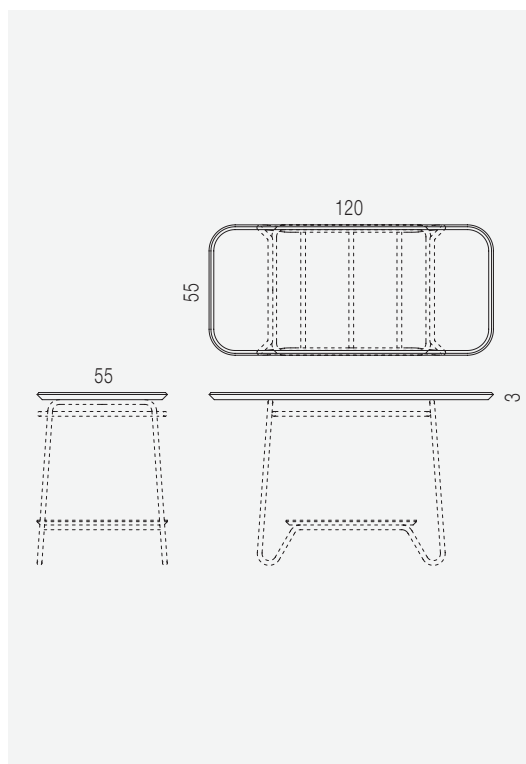

Vassoio in marmo e ripiano inferiore in marmo
Tray and lower shelf in marble

Marmo / Marble

Big tray

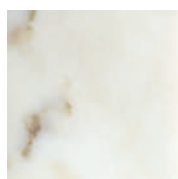

Bianco del Re



Calacatta Carrara



Bianco Carrara



Verde Ming

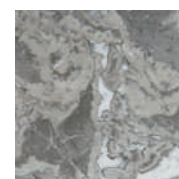

Grigio St. Marie

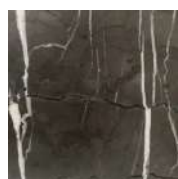

Persian Grey

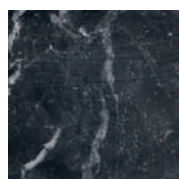

Nero Marquina

Marmo / Marble

Big tray

Top in legno e ripiano inferiore in marmo
Wood top and lower shelf in marble

Legno / Wood



Noce Matt
Walnut Matt

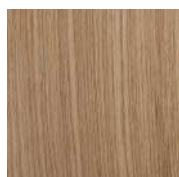

Rovere Naturale
Natural Oak

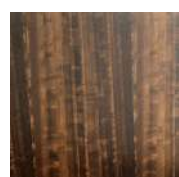

Eucalipto Frisè
Eucalyptus Frisè

Hashi| Easel

- Peso netto: 14 Kg
- Volume della cassa:
75x75x95 cm
- Peso lordo: 55 Kg

- Net weight: 14 kg
- Crate volume:
75x75x95 cm
- Gross weight: 55 kg

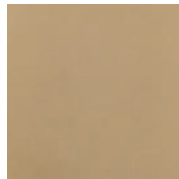
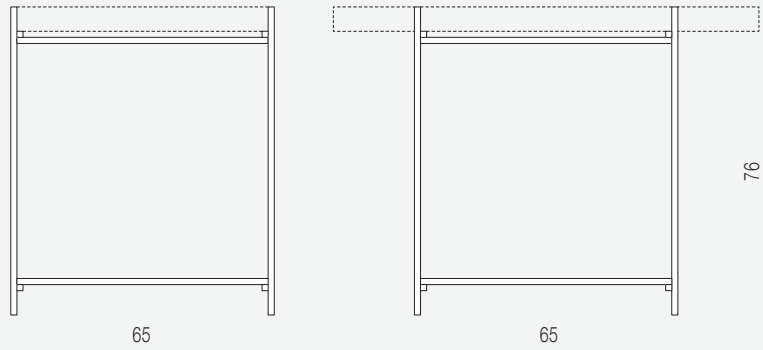

Bronzo Oro
Gold Bronze

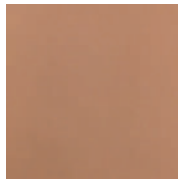

Bronzo Rosa
Pink Bronze

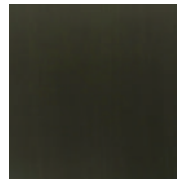

Bronzo Scuro
Dark Bronze

Metallo / Metal

- Peso netto Top Medium: 18,5 Kg
- Volume della cassa: 117x60x85 cm
- Peso lordo: 54,5 Kg

- Net weight Top Medium: 18,5 kg
- Crate volume: 117x60x85 cm
- Gross weight: 54,5 kg

- Peso netto Top Large: 37 Kg
- Volume della cassa: 222x60x85 cm
- Peso lordo: 92 Kg
- Net weight Top Large: 37 kg
- Crate volume: 222x60x85 cm
- Gross weight: 92 kg

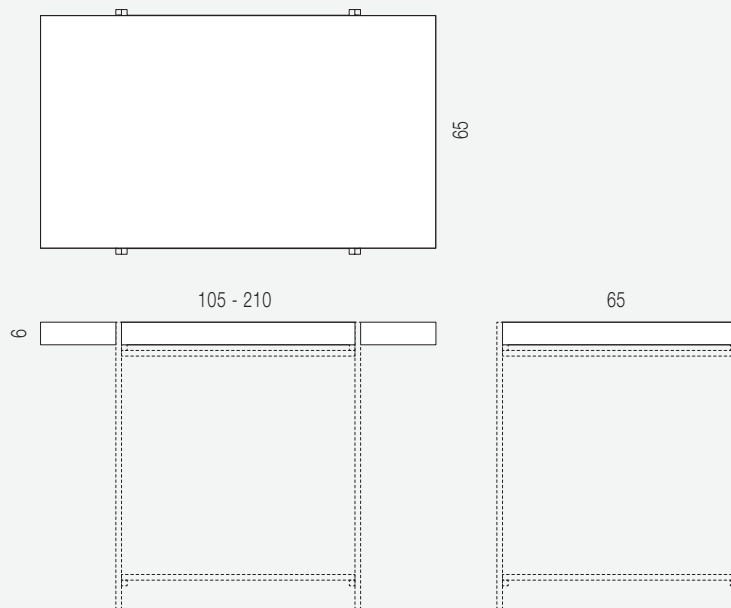

Noce Matt
Walnut Matt

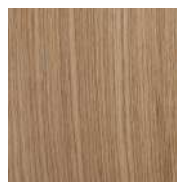

Rovere Naturale
Natural Oak



Eucalipto Frisè
Eucalyptus Frisè

Legno / Wood

105 x 65 x 6 cm

210 x 65 x 6 cm

Living Collection

Fairy

- Peso netto: 399 kg
- Volume della cassa:
265x80x80 cm
- Peso lordo: 480 kg
- Net weight: 399 kg
- Crate volume:
265x80x80 cm
- Gross weight: 480 kg

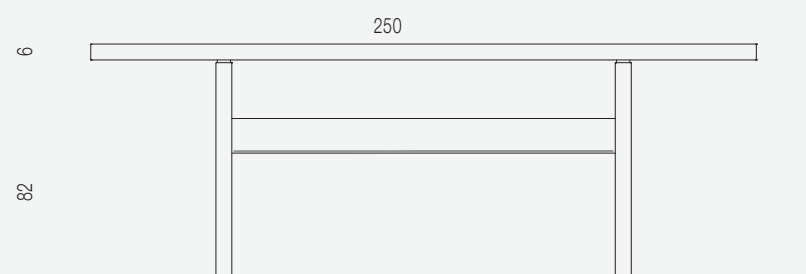

Marmo / Marble



Grigio Billiemi



Travertino Titanium



Travertino Paglierino

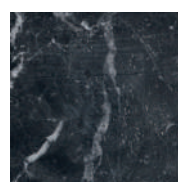

Nero Marquina



Calacatta Carrara

Marmo / Marble



Bianco Carrara

- Peso netto: 146 kg
- Volume della cassa: 205x60x80 cm
- Peso lordo: 220 kg
- Net weight: 146 kg
- Crate volume: 205x60x80 cm
- Gross weight: 220 kg

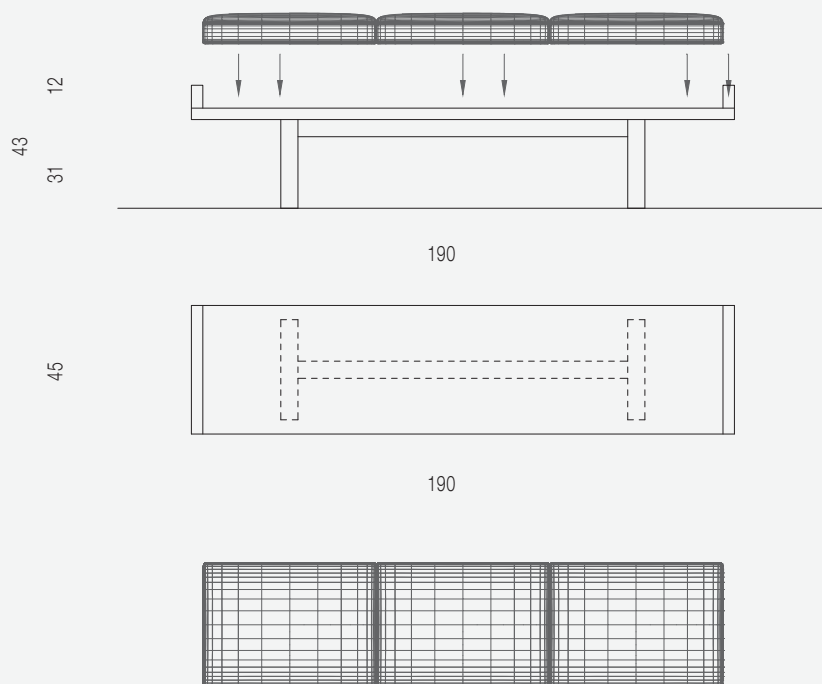

Marmo / Marble



Grigio Billiemi



Travertino Paglierino



Calacatta Carrara

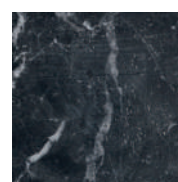

Nero Marquina



Gris Cevenol

Marmo / Marble



Olive Grey

*****disponibile con cuscino in pelle. Prezzo su richiesta.**

*****leather cushion available on request at an extra fee*****

BATHROOM COLLECTIVE

Arcaico

- Il top viene realizzato in legno (W) o in marmo (M) dello spessore di 3 cm.
- L'imballo dell'arcaico comprende il top, le colonne e il telaio.
- Peso top 160 in W: 32 kg
- Volume cassa: 178x87x126 cm
- Peso lordo: 498,5 Kg
- Peso top rotondo 160 in W: 65 kg
- Volume cassa: 179x59x187 cm
- Peso lordo: 672 Kg
- Peso top 200 in W: 40 kg
- Volume cassa: 219x87x126 cm
- Peso lordo: 638 Kg
- Peso top 240 in W: 48 kg
- Volume cassa: 258x87x126 cm
- Peso lordo: 686 Kg
- Peso top 160 in M: 116 kg
- Volume cassa: 178x87x126 cm
- Peso lordo: 583,5 Kg
- Peso top rotondo 160 in M: 206 kg
- Volume cassa: 179x59x187 cm
- Peso lordo: 822 Kg
- Peso top 200 in M: 146 kg
- Volume cassa: 219x87x126 cm
- Peso lordo: 744 Kg
- Peso top 240 in M: 175 kg
- Volume cassa: 258x87x126 cm
- Peso lordo: 813 Kg

- Top available in wood (W) or marble (M), 3 cm thick.
Crating includes top, columns and frame.

W Top 160

- Net weight: 32 kg
- Crate volume: 178x87x126 cm
- Gross weight: 498,5 kg

W Top 160 in round

- Net weight: 65 kg
- Crate volume: 179x59x187 cm
- Gross weight: 672 kg

W Top 200 in

- Net weight: 40 kg
- Crate volume: 219x87x126 cm
- Gross weight: 638 Kg

W Top 240 in

- Net weight: 48 kg
- Crate volume: 258x87x126 cm
- Gross weight: 686 kg

M Top 160 in

- Net weight: 116 kg
- Crate volume: 178x87x126 cm
- Gross weight: 583,5 kg

M Top 160 in round

- Net weight: 206 kg
- Crate volume: 179x59x187 cm
- Gross weight: 822 kg

M Top 200 in

- Net weight: 146 kg
- Crate volume: 219x87x26 cm
- Gross weight: 744 kg

M Top 240 in

- Net weight: 175 kg
- Crate volume: 258x87x126 cm
- Gross weight: 813 kg

- Peso colonna in marmo: kg 91,5
- Peso telaio 94 cm per top 160: kg 16
- Peso telaio 144 per top 200: kg 25
- Peso telaio 170 per top 240: kg 35

- Weight of marble column: kg 91,5
- Weight of 94 cm frame for top 160: kg 16
- Weight of 144 frame for top 200: kg 25
- Weight of 170 frame for top 240: kg 35

Arcaico

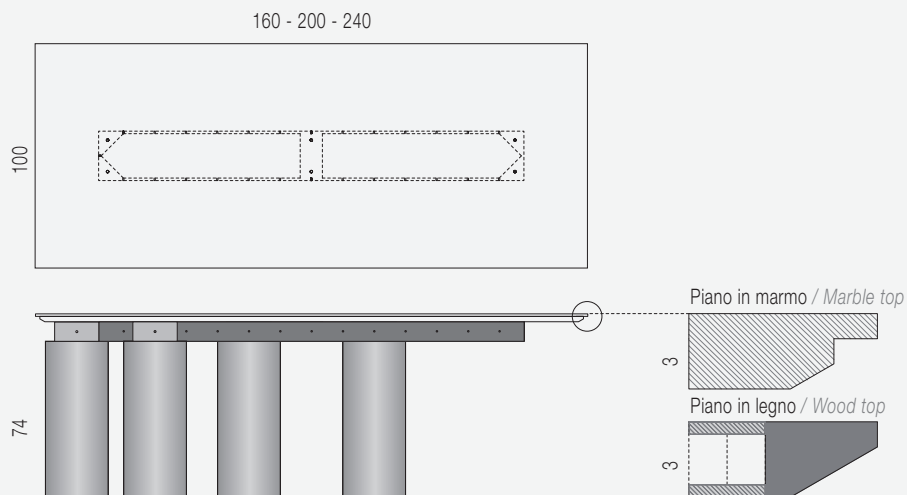

Arcaico Tondo | Round Top Arcaico

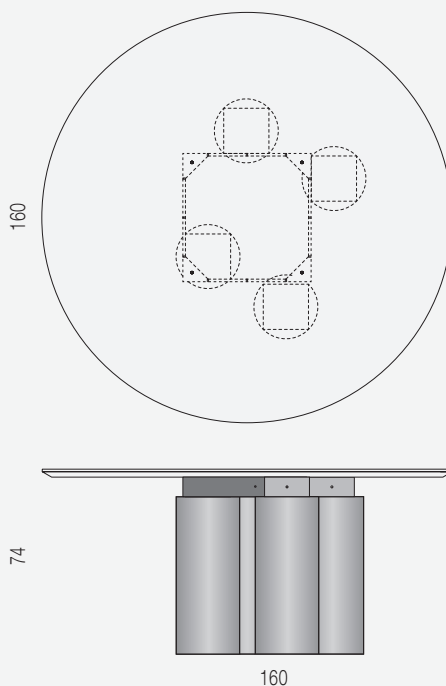

Telaio e Colonna | Frame and Column

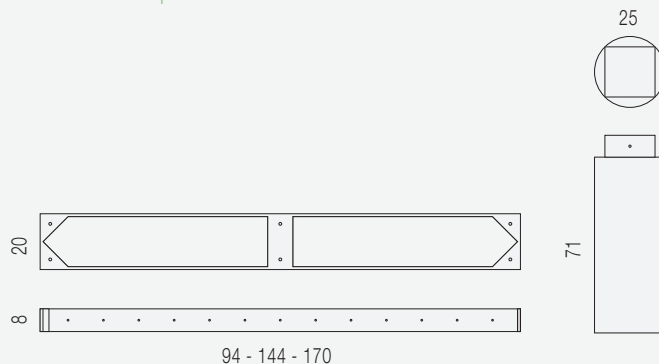

Top

Marmo / Marble

Lenght 160 cm
Lenght 200 cm
Lenght 240 cm
Diameter 160 cm



Calacatta Carrara



Calacatta Classico

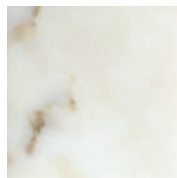

Bianco del Re



Bianco Carrara

Marmo / Marble

Lenght 160 cm
Lenght 200 cm
Lenght 240 cm
Diameter 160 cm

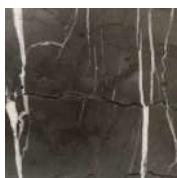

Persian Grey

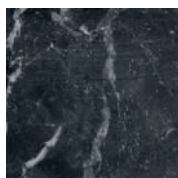

Nero Marquina



Silver Wave



Cappuccino



Dover White

Marmo / Marble

Lenght 160 cm
Lenght 200 cm
Lenght 240 cm
Diameter 160 cm



Travertino Navona



Cipollino Ondulato



Grigio Orobico



Onice Tramonto

Top

Legno / Wood

Lenght 160 cm
Lenght 200 cm
Lenght 240 cm
Diameter 160 cm

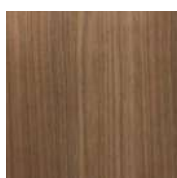

Noce Matt
Walnut Matt

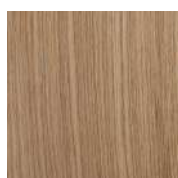

Rovere Naturale
Natural Oak

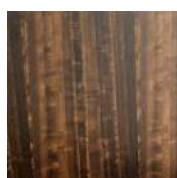

Eucalipto Frisè
Eucalyptus Frisè

Cilindri basi /
Cylinder bases



Calacatta Carrara



Calacatta Classico



Bianco del Re



Bianco Carrara

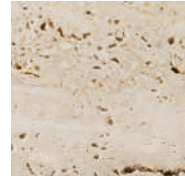

Travertino Paglierino

Marmo / *Marble*



Verde Ming

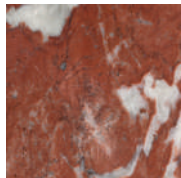

Rosso Francia

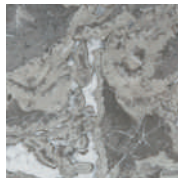

Grigio St. Marie



Persian Grey

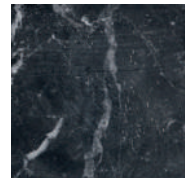

Nero Marquina

Marmo / *Marble*

Cilindri basi /
Cylinder bases

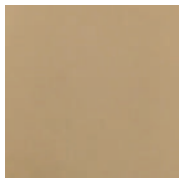

Bronzo Oro
Gold Bronze

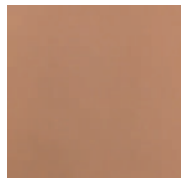

Bronzo Rosa
Pink Bronze

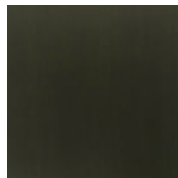

Bronzo Scuro
Dark Bronze

Metallo / *Metal*

- Peso netto: 419 Kg
 - Volume della cassa:
 258x110x146 cm
 - Peso lordo: 654 Kg

- Net weight: 419 kg
 - Crate volume:
 258x110x146 cm
 - Gross weight: 654 kg

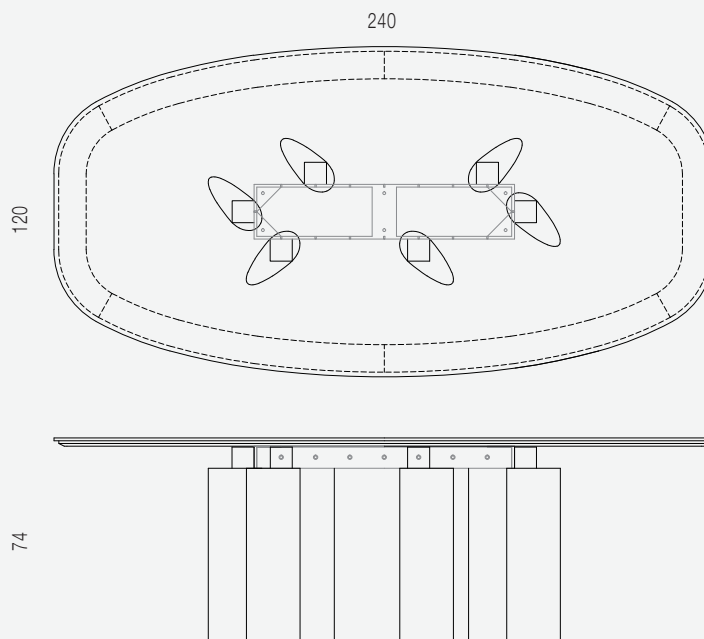

Marmo / Marble

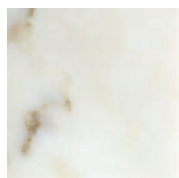

Bianco del Re



Calacatta Carrara



Calacatta Classico

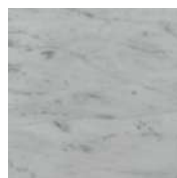

Bianco Carrara



Persian Grey

Marmo / Marble

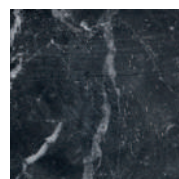

Nero Marquina

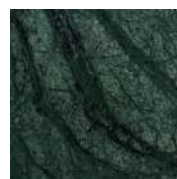

Verde Imperiale

Il prezzo include il top e 6 basi in marmo / Price includes top and 6 marble bases
 Marmi spessore 3 cm: Bianco del re, Bianco Carrara, Persian Grey, Nero marquina
 3 cm thick marbles: Bianco del re, Bianco Carrara, Persian Grey, Nero marquina
 Marmi spessore 2+1 cm: Calacatta Carrara, Calacatta Classico, Verde Imperiale
 2+1 cm thick marbles: Calacatta Carrara, Calacatta Classico, Verde Imperiale

BATHROOM COLLECTIVE

Kalende

Medium

- MEDIUM:
 - Peso netto: 240 Kg
 - Volume della cassa:
 165x120x175 cm
 - Peso lordo: 390 Kg
 - Net weight: 240 kg
 - Crate volume:
 165x120x175 cm
 - Gross weight: 390 kg

- MAXI:
 - Peso netto: 390 Kg
 - Volume della cassa:
 335x120x160 cm
 - Peso lordo: 610 Kg
 - Net weight: 390 kg
 - Crate volume:
 335x120x160 cm
 - Gross weight: 610 kg

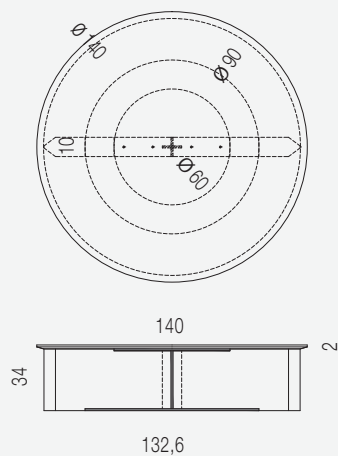

Maxi

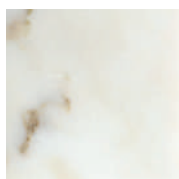
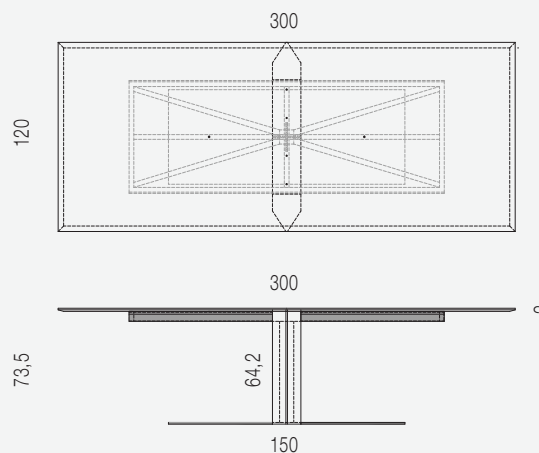

Bianco del Re



Calacatta Carrara



Calacatta Classico



Bianco Carrara

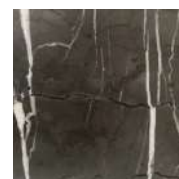

Persian Grey

Marmo / Marble

Medium
 Maxi

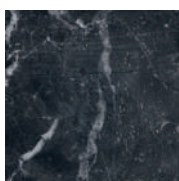

Nero Marquina

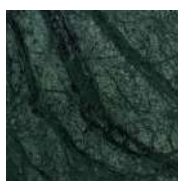

Verde Imperiale



Onice Tramonto



Rosso Lepanto

Marmo / Marble

Medium
 Maxi

- Peso netto: 160 kg
- Volume della cassa: 190x120x198 cm
- Peso lordo: 311 kg
- Net weight: 160 kg
- Crate volume: 190x120x198 cm
- Gross weight: 311 kg

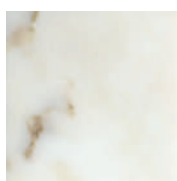
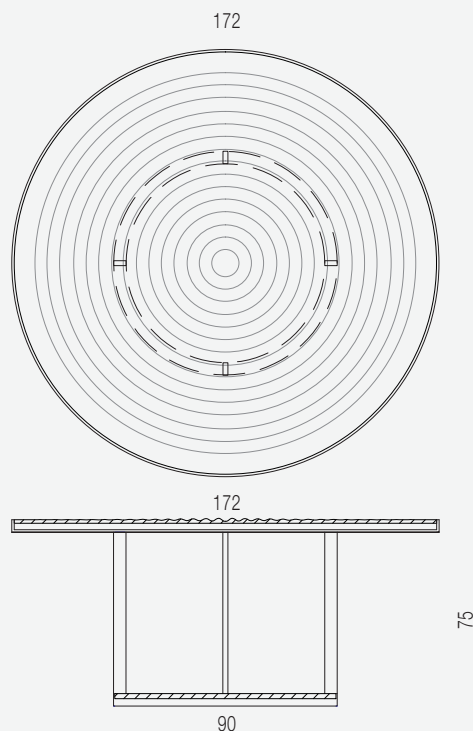

Bianco del Re



Verde Ming

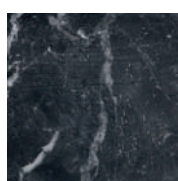

Nero Marquina



Rosso Diaspro



Cipollino Ondulato

Marmo / Marble

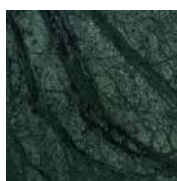

Verde Imperiale

Marmo / Marble

Struttura metallica/
Metal structure

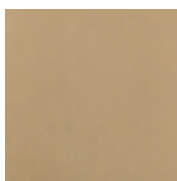

Bronzo Oro

+10%

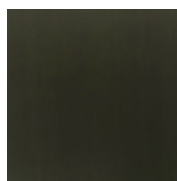

Bronzo Scuro

+ 10%

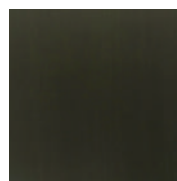

Nero Opaco

Metallo / Metal

BATHROOM COLLECTIVE

More

TAVOLO DIAM. 160 H73CM:

- Peso netto: 240 Kg
- Volume della cassa: 125x100x135 cm
- Peso lordo: 330 Kg

DINING TABLE H 160, 73 cm:

- Net weight: 240 kg
- Crate volume: 125x100x135 cm
- Gross weight: 330 kg

COFFEE TABLE DIAM. 120CM H30-39CM:

- Peso netto: 130 Kg
- Volume della cassa: 105x80x115 cm
- Peso lordo: 210 Kg

COFFEE TABLE DIAM. 120CM H30-39CM:

- Net weight: 130 kg
- Crate volume: 105x80x115 cm
- Gross weight: 210 kg

Dining table

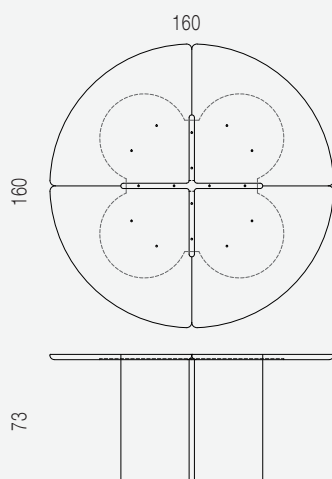

Coffee table diam. 120

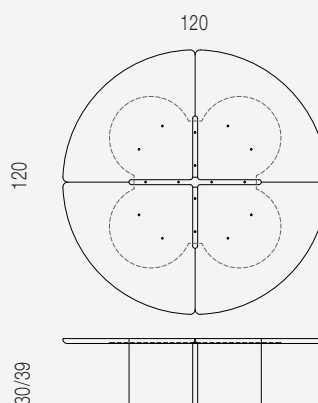

Marmo / Marble

Dining table ø 160 cm

Coffee table ø 120 cm



Calacatta Carrara

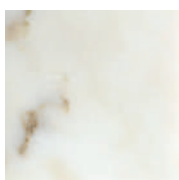

Bianco del Re



Bianco Carrara

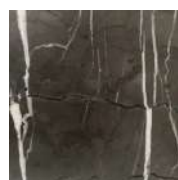

Persian Grey



Travertino Paglierino

Marmo / Marble

Dining table ø 160 cm

Coffee table ø 120 cm



Travertino Titanium

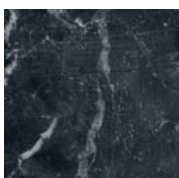

Nero Marquina

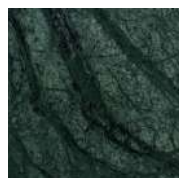

Verde Imperiale

- I prezzi indicati sono per il marmo. Opzione con dettaglio croce centrale in metallo con maggiorazione di 880,00€

- Price includes marble details. Option with central metal cross detail available with a surcharge of 880,00€

BATHROOM COLLECTIVE

Coffee table 120 x 120

COFFEE TABLE
120X120CM H30-39CM:
- Peso netto: 150 Kg
- Volume della cassa:
105x80x115 cm
- Peso lordo: 230 Kg

COFFEE TABLE
120x120cm H30-39cm:
- Net weight: 150 kg
- Crate volume:
105x80x115 cm
- Gross weight: 230 kg

COFFEE TABLE
140X90CM H30-39CM:
- Peso netto: 140 Kg
- Volume della cassa:
105x80x115 cm
- Peso lordo: 220 Kg

COFFEE TABLE
140X90CM H30-39CM:
- NET WEIGHT: 140 KG
- CRATE VOLUME:
105X80X115 CM
- GROSS WEIGHT: 220 kg

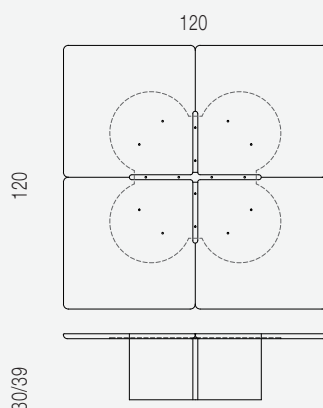

Coffee table 140 x 90

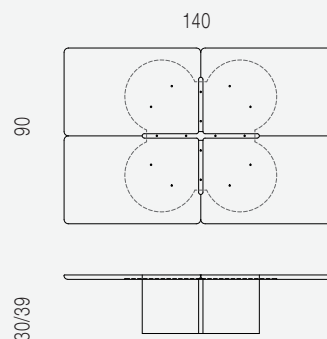

Calacatta Carrara

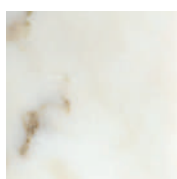

Bianco del Re

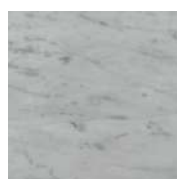

Bianco Carrara

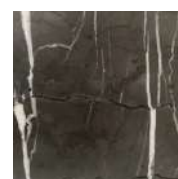

Persian Grey

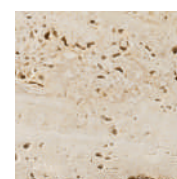

Travertino Paglierino

Marmo / Marble

Coffee table 120x120 cm
Coffee table 140x90 cm



Travertino Titanium

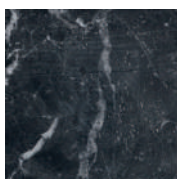

Nero Marquina

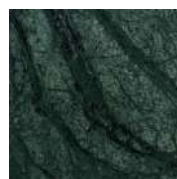

Verde Imperiale

Marmo / Marble

Coffee table 120x120 cm
Coffee table 140x90 cm

- I prezzi indicati sono per il marmo. Opzione con dettaglio croce centrale in metallo con maggiorazione di 1.040,00€
- Price includes marble details. Option with central metal cross detail available with a surcharge of 1.040,00€

BATHROOM COLLECTIVE

Jackie | Coffee Table

- Peso netto: 73,5 kg
- Volume della cassa: 148x141x69 cm
- Peso lordo: 211,5 kg
- Net weight: 73,5 kg
- Volume of the crate: 148x141x69 cm
- Gross weight: 211,5 kg

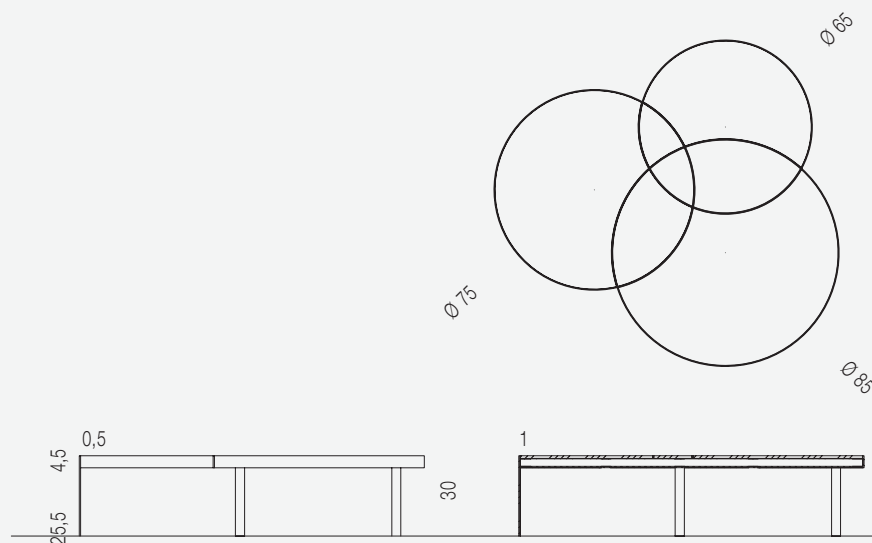

Marmo / Marble

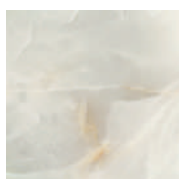

Onice Bianco



Onice Rosa



Onice Tramonto



Onice Verde Smeraldo



Light Sky Onyx

Marmo / Marble



Sodalite Blu



Calacatta Viola



Calacatta Classico

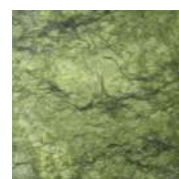

Verde Ming



Nero Portoro

Metalli / Metals

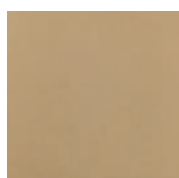

Bronzo Oro
Gold Bronze

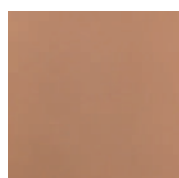

Bronzo Rosa
Pink Bronze



Bronzo Scuro
Dark Bronze

- I Top in marmo sono a venatura continua.
- Marble Tops come with continuity of veins.

BATHROOM COLLECTIVE

- Peso netto: 76 cm
- Volume della cassa: 144x144x69 cm
- Peso lordo: 209 kg
- Net weight: 76 cm
- Volume of the crate: 144x144x69 cm
- Gross weight: 209 kg

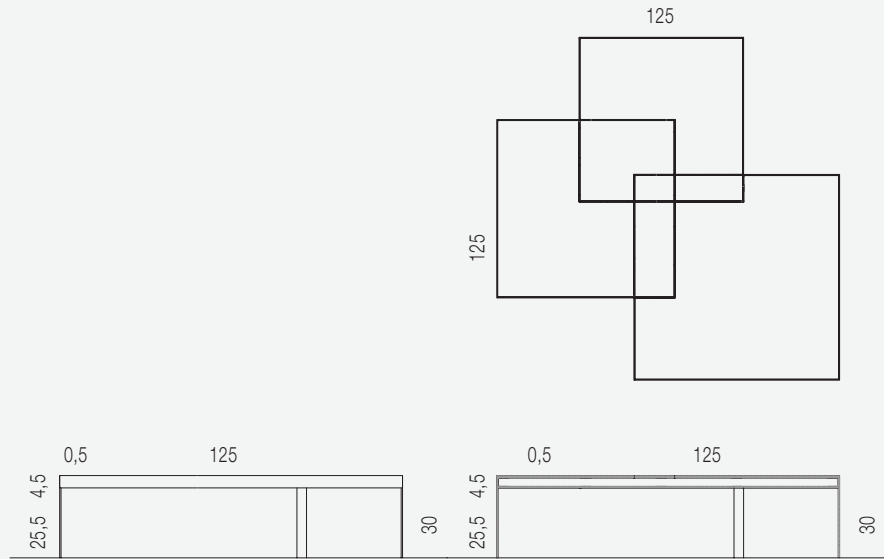

Mix Modern Marble

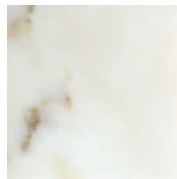

Bianco del Re



Nero Marquinia

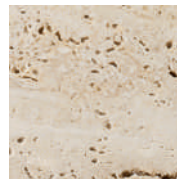

Travertino Paglierino



Persian Grey

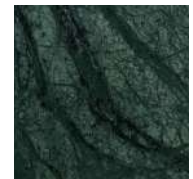

Verde Imperiale

Mix Luxury Marble

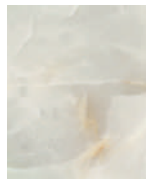

Onice Bianco



Calacatta Viola



Light Sky Onyx



Nero Portoro



Cappuccino



Rosso Diaspro

Metalli / Metals

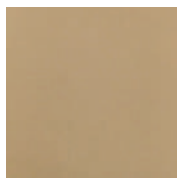

Bronzo Oro
Gold Bronze

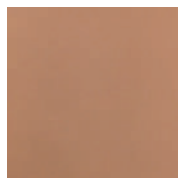

Bronzo Rosa
Pink Bronze

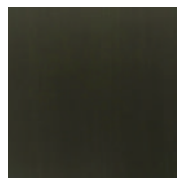

Bronzo Scuro
Dark Bronze

- I Top in marmo sono a venatura continua.
- Marble Tops come with continuity of veins.

Tangram Mini

- Peso netto: 110 kg
- Volume della cassa: 165x130x175 cm
- Base fornita assemblata, se non diversamente richiesto
- Net weight set: 110 kg
- Crate volume: 165x130x175 cm
- Base provided already assembled, unless differently requested

Square

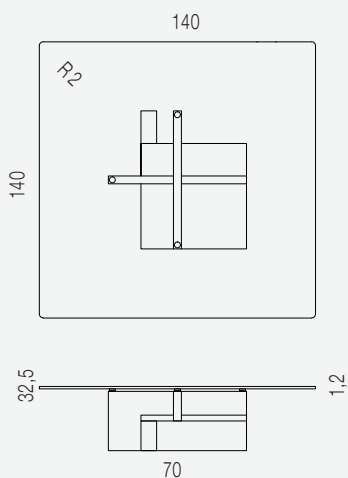

Round

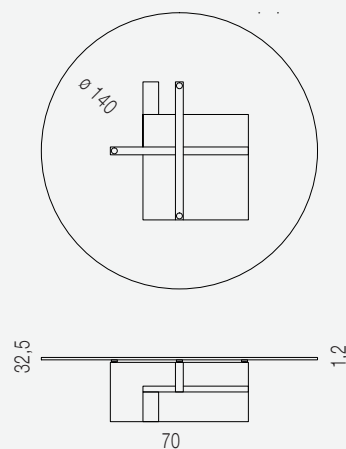

Marmo / Marble

- Square top
- Round top

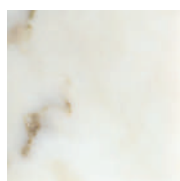

Bianco del Re



Calacatta Classico



Verde Ming

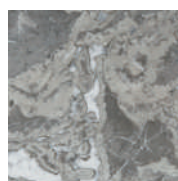

Grigio St. Marie

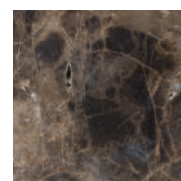

Emperador Dark

Marmo / Marble

- Square top
- Round top

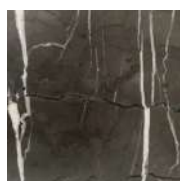

Persian Grey

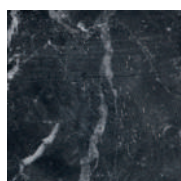

Nero Marquina



Nero Portoro



Rosso Francia

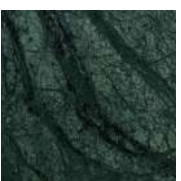

Verde Imperiale

Con top quadrato:
 - Peso netto: 345 Kg
 - Volume della cassa:
 160x110x168 cm
 - Peso lordo: 530 Kg

Square top:
 - Net weight: 345 kg
 - Crate volume:
 160x110x168 cm
 - Gross weight: 530 kg

Con top rotondo:
 - Peso netto: 331 Kg
 - Volume della cassa:
 160x110x168 cm
 - Peso lordo: 516 Kg

Round top:
 - Net weight: 331 kg
 - Crate volume:
 160x110x168 cm
 - Gross weight: 516 Kg

Round

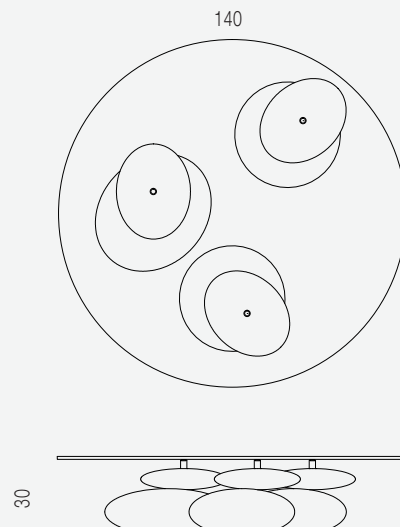

Square

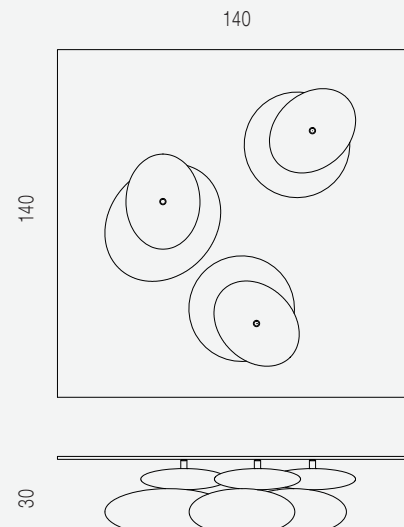

Top vetro rotondo Round glass top

Combinazione marmi "A" Marble mix "A"

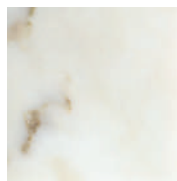

Bianco del Re



Persian Grey

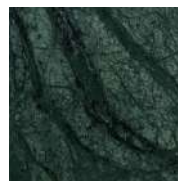

Verde Imperiale

Combinazione marmi "B" Marble mix "B"

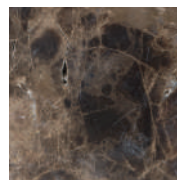

Emperador Dark



Nero Marquina



Bianco Carrara



Travertino Paglierino



Grigio St. Marie

Top vetro quadrato Square glass top

Combinazione marmi "A" Marble mix "A"

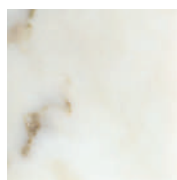

Bianco del Re

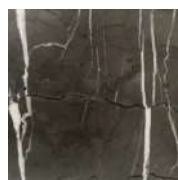

Persian Grey

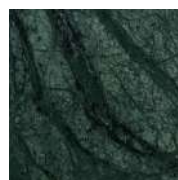

Verde Imperiale

Combinazione marmi "B" Marble mix "B"

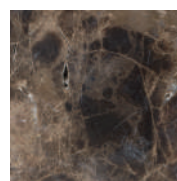

Emperador Dark

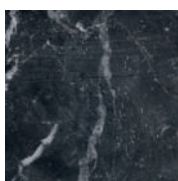

Nero Marquina



Bianco Carrara



Travertino Paglierino

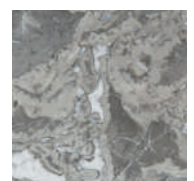

Grigio St. Marie

- Combinazione marmi "A+B" disponibile su richiesta
 - marble mix "A+B" available upon request

BATHROOM COLLECTIVE

Nodo

- Peso netto: 22,5 kg
- Volume della cassa: 70x67x78 cm
- Peso lordo: 61,5 kg
- Net weight: 22,5 kg
- Volume of the crate: 70x67x78 cm
- Gross weight: 61,5 kg

Nodo Mini

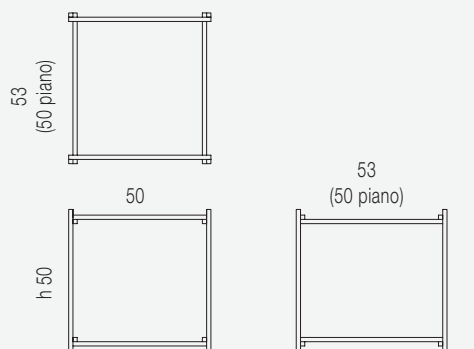

- Peso netto: 41 kg
- Volume della cassa: 117x73x75 cm
- Peso lordo: 96 kg
- Net weight: 41 kg
- Volume of the crate: 117x73x75 cm
- Gross weight: 96 kg

Nodo Medium

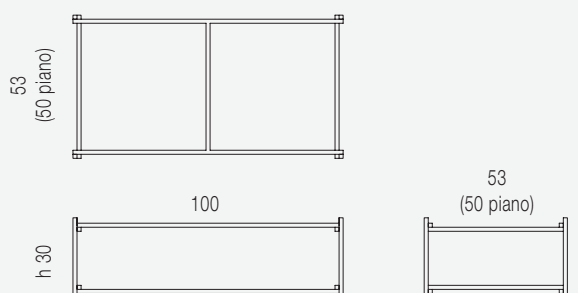

- Peso netto: 61,5 kg
- Volume della cassa: 137x73x108 cm
- Peso lordo: 152,5 kg
- Net weight: 61,5 kg
- Volume of the crate: 137x73x108 cm
- Gross weight: 152,5 kg

Nodo Maxi



- Peso netto: 98 kg
- Volume della cassa: 139x90x147 cm
- Peso lordo: 203 kg
- Net weight: 98 kg
- Volume of the crate: 139x90x147 cm
- Gross weight: 203 kg

Nodo Consolle

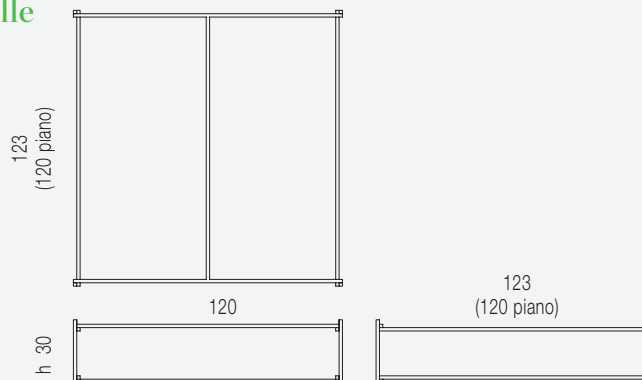

Marmo / Marble

Nodo Mini
Nodo Medium
Nodo Maxi
Nodo Consolle

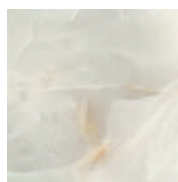

Onice Bianco



Onice Rosa



Onice Tramonto



Onice Verde Smeraldo



Sodalite Blu

Marmo / Marble

Nodo Mini
Nodo Medium
Nodo Maxi
Nodo Consolle

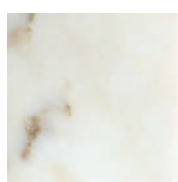

Bianco del Re



Calacatta Carrara



Calacatta Viola



Verde Ming

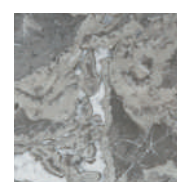

Grigio St. Marie

Marmo / Marble

Nodo Mini
Nodo Medium
Nodo Maxi
Nodo Consolle

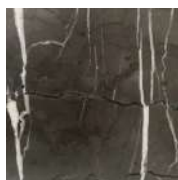

Persian Grey



Cappuccino



Nero Portoro

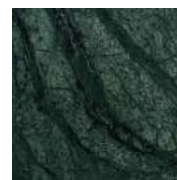

Verde Imperiale

Metalli / Metals

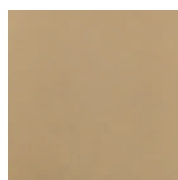

Bronzo Oro
Gold Bronze

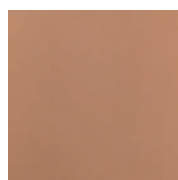

Bronzo Rosa
Pink Bronze

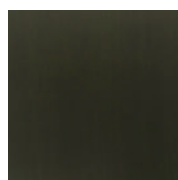

Bronzo Scuro
Dark Bronze

- Top disponibile anche con finitura Ducale-covering collection.
- Top available in Ducale finish-covering collection.

BATHROOM COLLECTIVE

Moon

Seating

Table

Seating

- Peso netto: 23 Kg
- Volume della cassa: 68x63x78 cm
- Peso lordo: 67 Kg

Table

- Peso netto: 29 Kg
- Volume della cassa: 68x68x79 cm
- Peso lordo: 76 Kg

Seating

- Net weight: 23 kg
- Crate volume: 68x63x78 cm
- Gross weight: 67 kg

Table

- Net weight: 29 kg
- Crate volume: 68x68x79 cm
- Gross weight: 76 kg

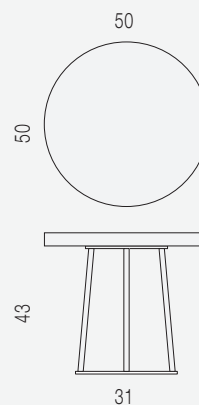
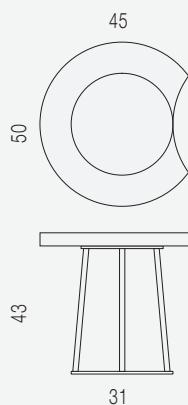

Noce Matt
Walnut Matt



Rovere Naturale
Light Oak



Eucalipto Frisé
Eucalyptus Frisé

Legno / Wood

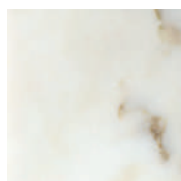

Bianco del Re



Calacatta Carrara



Bianco Carrara

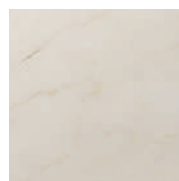

Crema Marfil

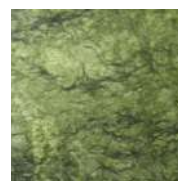

Verde Ming

Marmo / Marble



Grigio St. Marie

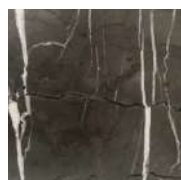

Persian Grey

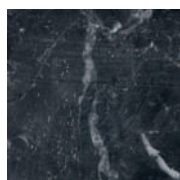

Nero Marquinia



Nero Portoro

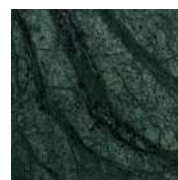

Verde Imperiale

Marmo / Marble



Travertino Paglierino

Marmo / Marble

- La struttura metallica inclusa nel prezzo è verniciata di nero.
- The metal structure included into the price is black painted.

BATHROOM COLLECTIVE

ROUND

- Peso netto marmo: 77 kg
- Volume della cassa compresa la seduta: 90x65x60 cm
- Peso lordo: 122 Kg

- Net weight of marble: 77 kg
- Crate volume: 90x65x60 cm
- Gross weight: 122 kg

SMALL OVAL

- Peso netto marmo: 94 kg
- Volume della cassa compresa la seduta: 90x60x60 cm
- Peso lordo: 140 Kg

- Net weight of marble: 94 kg
- Crate volume: 90x60x60 cm
- Gross weight: 140 kg

BIG OVAL

- Peso netto marmo: 121 kg
- Volume della cassa compresa la seduta: 90x60x60 cm
- Peso lordo: 179 Kg

- Net weight of marble: 121 kg
- Crate volume: 90x60x60 cm
- Gross weight: 179 kg

Round

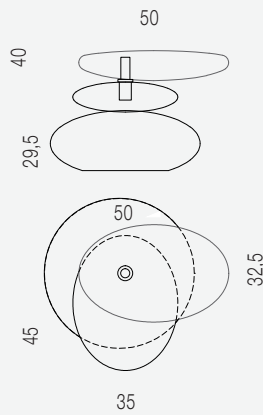

Small Oval

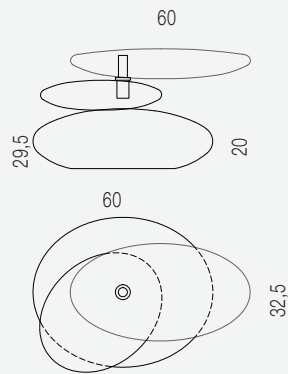

Big Oval

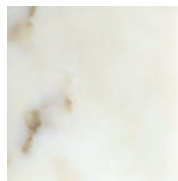
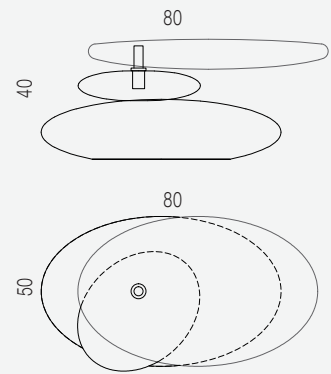

Bianco del Re



Bianco Carrara



Persian Grey

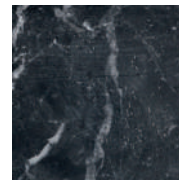

Nero Marquina

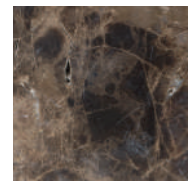

Emperador Dark

Marmo / Marble

- Round 50 cm
- Small oval 50x60x20 cm
- Big oval 50x80x20 cm



Travertino Paglierino

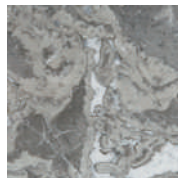

Grigio St. Marie

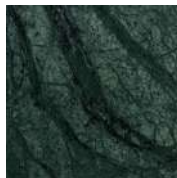

Verde Imperiale

Marmo / Marble

- Round 50 cm
- Small oval 50x60x20 cm
- Big oval 50x80x20 cm

Seduta

Wooden seat



Larice Bianco
White Larch



Larice Invecchiato
Aged Larch

Legno / Wood

- 50 cm
- 60 cm
- 80 cm

Keir è composto da 2 basi in marmo e 1 seduta in legno. Il prezzo indicato per il marmo si intende per due basi
Keir is composed by two marble bases and a wooden seat. Marble price includes two marble bases.

BATHROOM COLLECTIVE

ROUND

- Peso netto marmo: 77 kg
- Volume della cassa compresa la seduta: 90x65x60 cm
- Peso lordo: 122 Kg
- Net weight of marble: 77 kg
- Crate volume seat included: 90x65x60 cm
- Gross weight: 122 kg

SMALL OVAL

- Peso netto marmo: 94 kg
- Volume della cassa compresa la seduta: 90x60x60 cm
- Peso lordo: 140 Kg
- Net weight of marble: 94 kg
- Crate volume seat included: 90x60x60 cm
- Gross weight: 140 kg

BIG OVAL

- Peso netto marmo: 121 kg
- Volume della cassa compresa la seduta: 90x60x60 cm
- Peso lordo: 179 Kg
- Net weight of marble: 121 kg
- Crate volume seat included: 90x60x60 cm
- Gross weight: 176 kg

Round

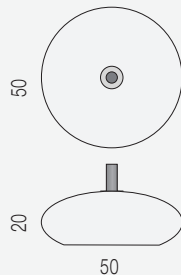

Small Oval

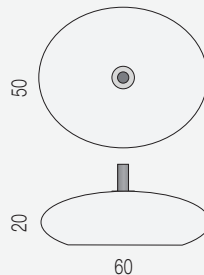

Big Oval

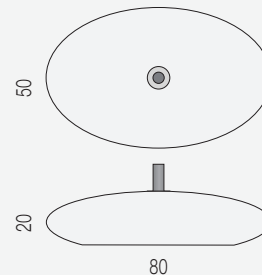

Basi / Bases

Marmo / Marble

- Round 50x50x20 cm
- Small oval 50x60x20 cm
- Big oval 50x80x20 cm

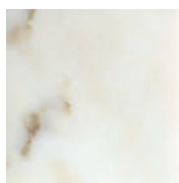

Bianco del Re



Calacatta Carrara



Bianco Carrara



Travertino Paglierino

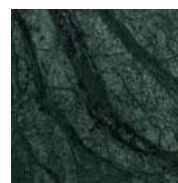

Verde Imperiale

Marmo / Marble

- Round 50x50x20 cm
- Small oval 50x60x20 cm
- Big oval 50x80x20 cm

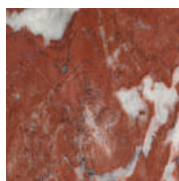

Rosso Francia

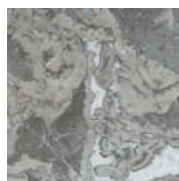

Grigio St. Marie

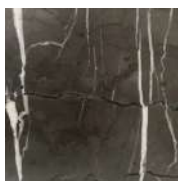

Persian Grey

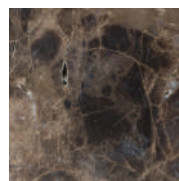

Emperador Dark

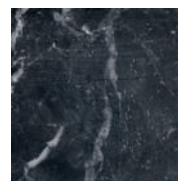

Nero Marquina

Il sistema Pavè è composto da una base in marmo chiamata "Stone" (pag. 64) e da una seduta in legno da combinare (pag. 65) oppure un top uso tavolo (pag. 67).

The Pavè system is composed by a stone base (pag. 64) and a wooden seat (pag. 65) or a flat table top (pag. 67).

ROUND SEATING

- Peso netto seduta: 17 Kg
- Volume della cassa compresa la base: 90x60x60 cm
- Peso lordo: 122 Kg
- Net weight: 17 kg
- Crate volume base included: 90x60x60 cm
- Gross weight: 122 kg

SMALL OVAL SEATING

- Peso netto seduta: 18 Kg
- Volume della cassa compresa la base: 90x60x60 cm
- Peso lordo: 140 Kg
- Net weight: 18 kg
- Crate volume base included: 90x60x60 cm
- Gross weight: 140 kg

BIG OVAL SEATING

- Peso netto seduta: 30 Kg
- Volume della cassa compresa la base: 90x60x60 cm
- Peso lordo: 179 Kg
- Net weight: 30 kg
- Crate volume base included: 90x60x60 cm
- Gross weight: 179 kg

Round Seating

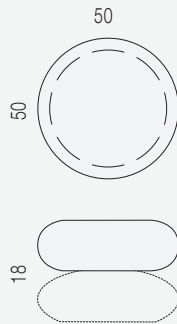

Small Oval Seating

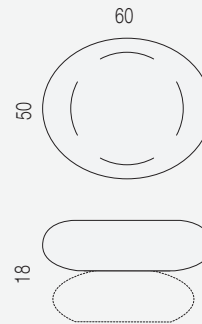

Big Oval Seating

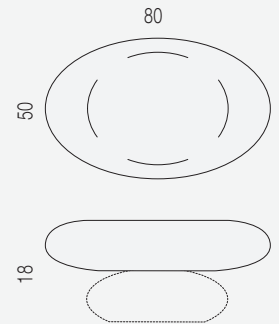

Seduta / Seat



Larice Bianco
White Larch



Larice Invecchiato
Aged Larch

Legno / Wood

Round 50x50x18 cm

Small oval 50x60x18 cm

Big oval 50x80x18 cm

Legno verniciato / Painted wood



Verniciato Lucido
(colore RAL a scelta)
Glossy Painted (Any RAL color)

Round 50x50x18 cm

Small oval 50x60x18 cm

Big oval 50x80x18 cm

LOG 160

- Peso netto trave con basi small oval e big oval: 245 Kg
- Volume della cassa comprese le due basi: 179x102x66 cm
- Peso lordo: 384 Kg

- *Net weight of beam with small oval/big oval base: 245 kg*
- *Crate volume including the two bases: 179x102x66 cm*
- *Gross weight: 384 kg*

LOG 200

- Peso netto trave con basi small oval e big oval: 252 Kg
- Volume della cassa comprese le due basi: 220x102x66 cm
- Peso lordo: 406 Kg

- *Net weight of beam with small oval/big oval base: 252 kg*
- *Crate volume including the two bases: 220x102x66 cm*
- *Gross weight: 406 kg*

LOG 240

- Peso netto trave con basi small oval e big oval: 260 Kg
- Volume della cassa comprese le due basi: 260x102x66 cm
- Peso lordo: 428 Kg

- *Net weight of beam with small oval/big oval base: 260 kg*
- *Crate volume including the two bases: 260x102x66 cm*
- *Gross weight: 428 kg*

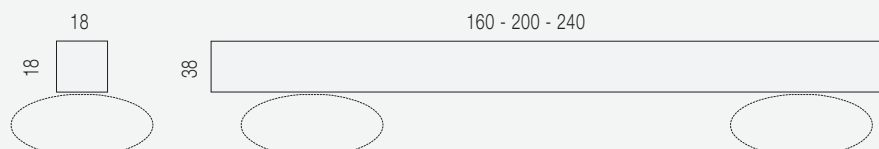

Panca / Square log

Legno / Wood

Log 160 - 160 cm

Log 200 - 200 cm

Log 240 - 240 cm



Larice Bianco
White Larch



Larice Invecchiato
Aged Larch

Legno verniciato / Painted wood

Log 160 - 160 cm

Log 200 - 200 cm

Log 240 - 240 cm



Verniciato Lucido
(colore RAL a scelta)
Glossy Painted (Any
RAL color)



Copertura in
Cuoio Naturale
Natural leather
covering

Legno listellare spazzolato.
Laminated brushed wood.

BATHROOM COLLECTIVE

- DRINK 50 CM
- Peso netto con base round: 86,5 Kg
 - Volume della cassa: 90x60x65 cm
 - Peso lordo: 115,5 Kg
 - *Net weight - round base: 86,5 kg*
 - *Crate volume: 90x60x65 cm*
 - *Gross weight: 115,5 kg*
- Peso netto con base small oval: 103,5 Kg
 - Volume della cassa: 90x60x65 cm
 - Peso lordo: 132,5 Kg
 - *Net weight - small oval base: 103,5 kg*
 - *Crate volume: 90x60x65 cm*
 - *Gross weight: 132,5 kg*
- Peso netto con base big oval: 130,5 Kg
 - Volume della cassa: 90x60x65 cm
 - Peso lordo: 159,5 Kg
 - *Net weight - big oval base: 130,5 kg*
 - *Crate volume: 90x60x65 cm*
 - *Gross weight: 159,5 kg*

Drink 50

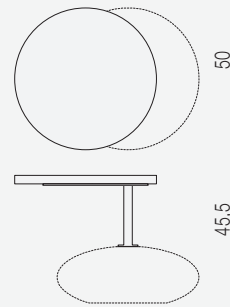

- DRINK 80 CM
- Peso netto con base round: 93,5 Kg
 - Volume della cassa: 90x60x65 cm
 - Peso lordo: 133,5 Kg
 - *Net weight - round base: 93,5 kg*
 - *Crate volume: 90x60x65 cm*
 - *Gross weight: 133,5 kg*
- Peso netto con base small oval: 110,5 Kg
 - Volume della cassa: 90x60x65 cm
 - Peso lordo: 150,5 Kg
 - *Net weight - small oval base: 110,5 kg*
 - *Crate volume: 90x60x65 cm*
 - *Gross weight: 150,5 kg*
- Peso netto con base big oval: 137,5 Kg
 - Volume della cassa: 90x60x65 cm
 - Peso lordo: 177,5 Kg
 - *Net weight - big oval base: 137,5 kg*
 - *Crate volume: 90x60x65 cm*
 - *Gross weight: 177,5 kg*

Drink 80

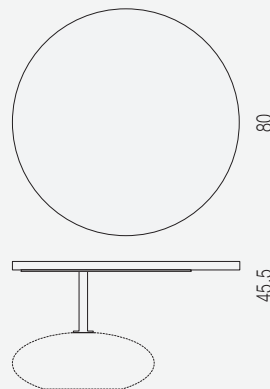

Seduta / Seat

Legno / Wood

Diameter 50 cm
Diameter 80 cm



Larice Bianco
White Larch



Larice Invecchiato
Aged Larch

Oasi

Oasi n. 1

- Peso netto: 136 Kg
- Volume della cassa: 126x162x118 cm
- Peso lordo: 240 Kg
- Net weight: 136 kg
- Crate volume: 126x162x118 cm
- Gross weight: 240 kg

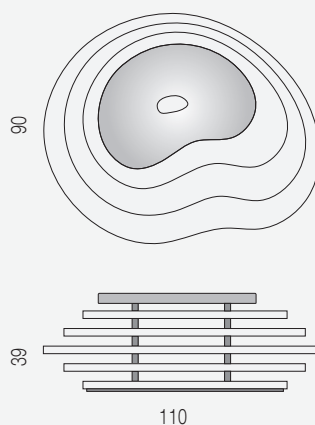

Oasi n. 2

- Peso netto: 179 Kg
- Volume della cassa: 140x135x99 cm
- Peso lordo: 270 Kg
- Net weight: 179 kg
- Crate volume: 140x135x99 cm
- Gross weight: 270 kg

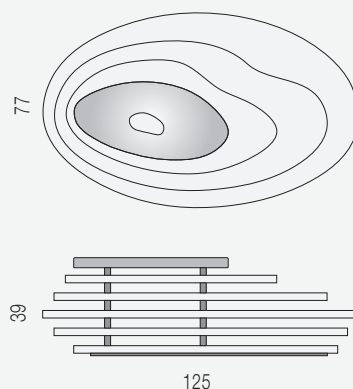

Oasi n. 3

- Peso netto: 307 Kg
- Volume della cassa: 195x148x112 cm
- Peso lordo: 450 Kg
- Net weight: 307 kg
- Crate volume: 195x148x112 cm
- Gross weight: 450 kg

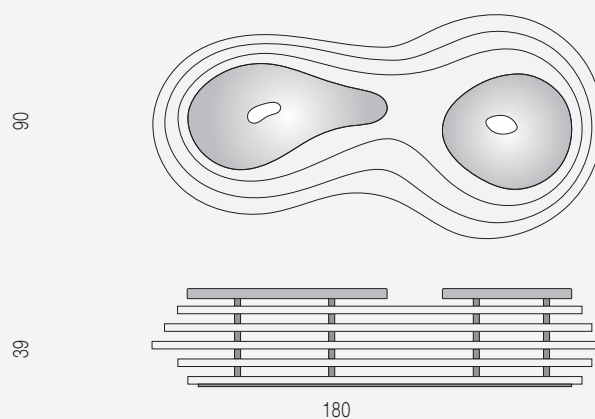

Base in marmo /
Marble base

Marmo / Marble

- Oasi n. 1
- Oasi n. 2
- Oasi n. 3



Travertino Noce

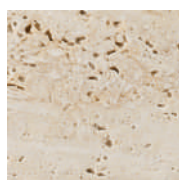

Travertino Paglierino



Bianco Carrara

Seduta in legno /
Wood Seat



Larice
Invecchiato
Aged Larch

PEDINA STOOL

- Peso netto: 28 Kg
- Volume della cassa: 55x55x78 cm
- Peso lordo: 66 Kg
- Net weight: 28 kg
- Crate volume: 55x55x78 cm
- Gross weight: 66 kg

PEDINA TABLE 60 CM

- Peso netto: 42 Kg
- Volume della cassa: 76x64x85 cm
- Peso lordo: 101 Kg
- Net weight: 42 kg
- Crate volume: 76x64x85 cm
- Gross weight: 101 kg

PEDINA TABLE 100 CM

- Peso netto: 70 Kg
- Volume della cassa: 116x67x125 cm
- Peso lordo: 163 Kg
- Net weight: 70 kg
- Crate volume: 116x67x125 cm
- Gross weight: 163 kg

Pedina Stool



Pedina Table 60

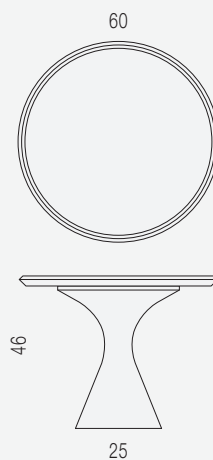

Pedina Table 100

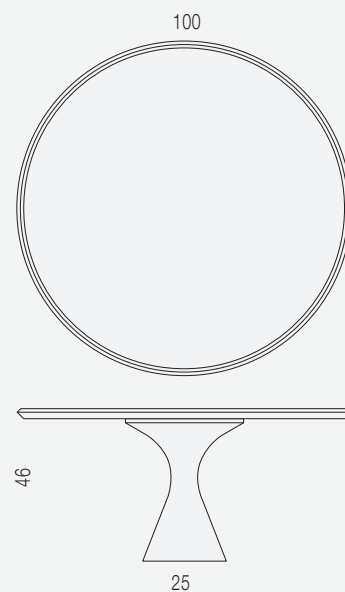

Marmo / Marble

- Pedina stool
- Pedina table 60 cm
- Pedina table 100 cm

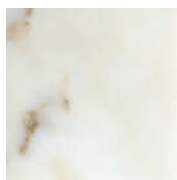

Bianco del Re



Calacatta Carrara

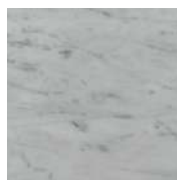

Bianco Carrara

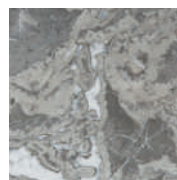

Grigio St. Marie



Persian Grey

Marmo / Marble

- Pedina stool
- Pedina table 60 cm
- Pedina table 100 cm

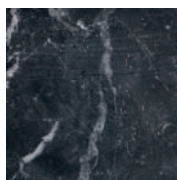

Nero Marquina

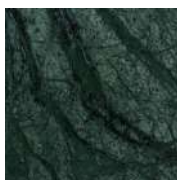

Verde Imperiale

Torre

Torre 60

TORRE 60 CM

- Peso netto: 53 Kg
- Volume della cassa: 76x64x92 cm
- Peso lordo: 117 Kg
- Net weight: 53 kg
- Crate volume: 76x64x92 cm
- Gross weight: 117 kg

TORRE 100 CM

- Peso netto: 81 Kg
- Volume della cassa: 115x100x125 cm
- Peso lordo: 176 Kg
- Net weight: 81 kg
- Crate volume: 115x100x125 cm
- Gross weight: 176 kg

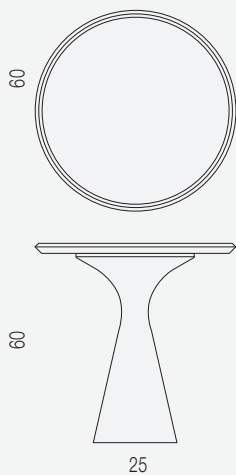

Torre 100

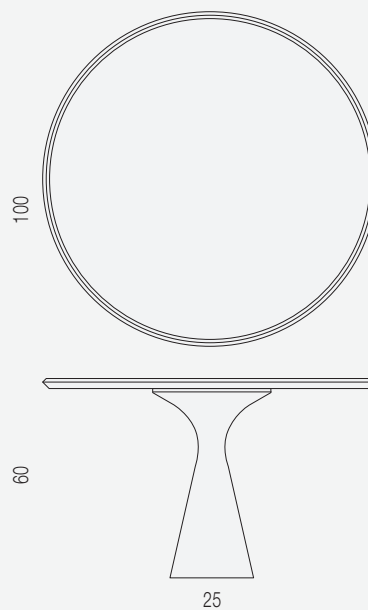

Marmo / Marble

Torre 60 cm
Torre 100 cm

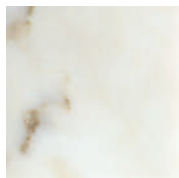

Bianco del Re



Calacatta Carrara

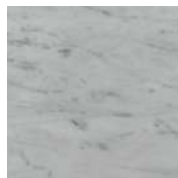

Bianco Carrara



Verde Ming



Grigio St. Marie

Marmo / Marble

Torre 60 cm
Torre 100 cm

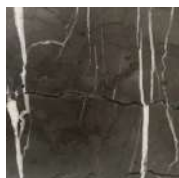

Persian Grey

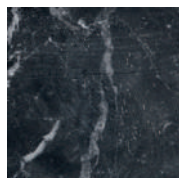

Nero Marquina

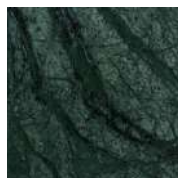

Verde Imperiale

- Peso netto: 195 Kg
- Volume della cassa:
158x120x167 cm
- Peso lordo: 386 Kg
- Weight: 195 kg
- Volume of the crate:
158x120x167 cm
- Gross weight: 386 kg

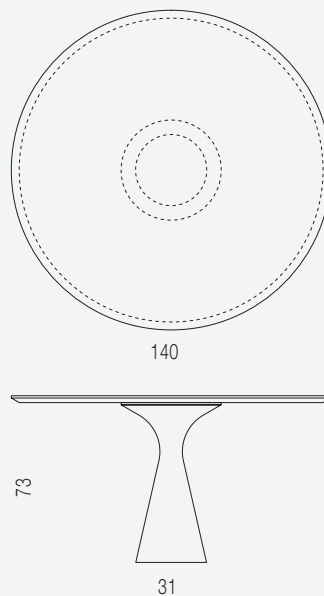

Marmo / Marble

Torre Maxi

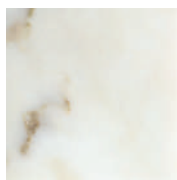

Bianco del Re



Calacatta Carrara

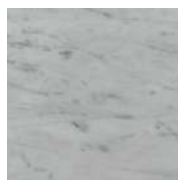

Bianco Carrara



Verde Ming



Grigio St. Marie

Marmo / Marble

Torre Maxi

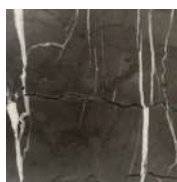

Persian Grey



Nero Marquina

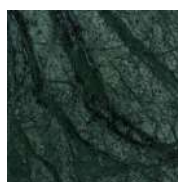

Verde Imperiale

Vis à Vis

Single

SINGLE VIS À VIS
- Peso netto: 273 Kg
- Volume della cassa:
193x78x81 cm
- Peso lordo: 341 Kg
- Net weight: 273 kg
- Crate volume:
193x78x81 cm
- Gross weight: 341 kg

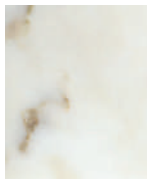
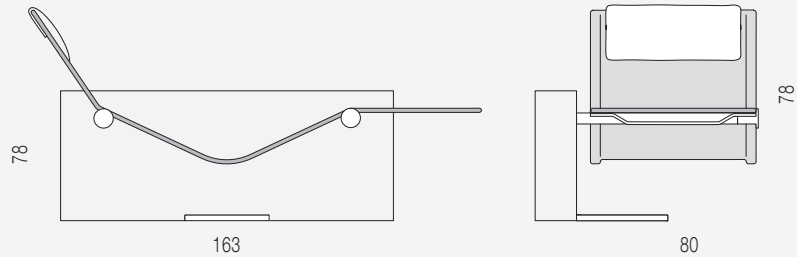

Bianco del Re



Calacatta Classico



Bianco Carrara



Grigio St. Marie



Persian Grey



Nero Marquina

Marmo / Marble

Seduta in midollino naturale
Seat in natural wicker

Seduta in midollino tecnico
*Sitting in technical wicker
(Lloyd loom)*

Cuscino / Pillow



Lino Naturale
Natural Linen

Sedute / Seating



Midollino Naturale
Natural Wicker

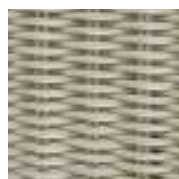

Midollino Tecnico
su richiesta
*Technical Wicker
(Lloyd Loom)
on request*

BATHROOM COLLECTIVE

Double

DOUBLE VIS À VIS
 - Peso netto: 305 Kg
 - Volume della cassa:
 193x105x81 cm
 - Peso lordo: 387 Kg
 - Net weight: 305 kg
 - Crate volume:
 193x105x81 cm
 - Gross weight: 387 kg

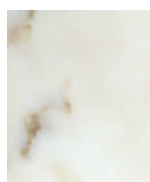
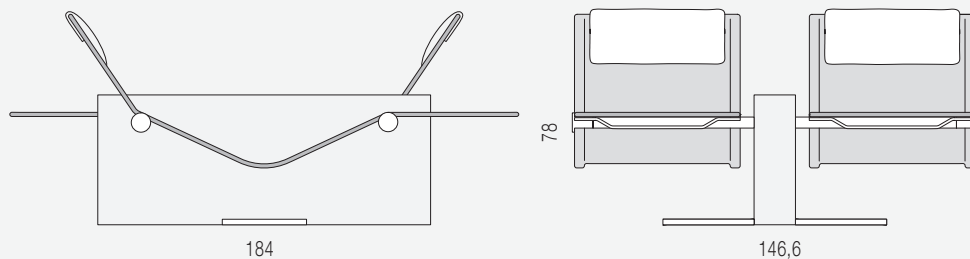

Bianco del Re



Calacatta Classico



Bianco Carrara



Grigio St. Marie



Persian Grey



Nero Marquina

Marmo / Marble

Seduta in midollino naturale
Seat in natural wicker

Seduta in midollino tecnico
*Sitting in technical wicker
 (lloyd loom)*



Cuscino / Pillow

Lino Naturale
Natural Linen



Sedute / Seating

Midollino Naturale
Natural Wicker

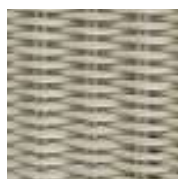

Midollino Tecnico
 su richiesta
*Technical Wicker
 (Lloyd Loom)
 on request*

BATHROOM COLLECTIVE

Shiro

Single

Composizione a 5 ripiani

- Peso netto: 185,5 Kg

- Volume della cassa:

132x78x87 cm

- Peso lordo: 239,5 Kg

5 shelves composition

- Net weight: 185,5 kg

- Crate volume:

132x78x87 cm

- Gross weight: 239,5 kg

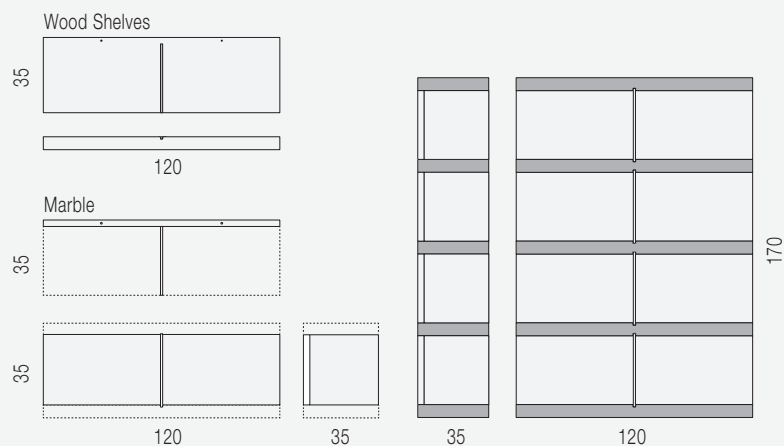

**Marmo di fondo per /
Supporting marble
structure for**

Marmo / Marble

2 piani / 2 shelves

3 piani / 3 shelves

4 piani / 4 shelves

5 piani / 5 shelves



Calacatta Carrara



Calacatta Classico

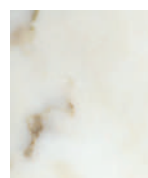

Bianco del Re



Bianco Carrara



Grigio St. Marie



Verde Ming

Marmo / Marble

2 piani / 2 shelves

3 piani / 3 shelves

4 piani / 4 shelves

5 piani / 5 shelves



Persian Grey

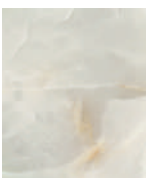

Onice Bianco



Cappuccino



Nero Marquina



Travertino Titanium



Verde Bamboo

Mensole / Shelves

Legno / Wood

2 piani / 2 shelves

3 piani / 3 shelves

4 piani / 4 shelves

5 piani / 5 shelves



Larice Bianco
White Larch



Noce Matt
Walnut Matt

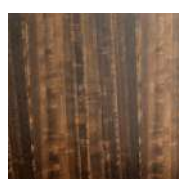

Eucalipto Frisè
Eucalyptus Frisè

- Composizione a 5 ripiani
- Peso netto: 230 Kg
 - Volume della cassa: 132x78x87 cm
 - Peso lordo: 284 Kg
- 5 shelves composition
- Net weight: 230 kg
 - Crate volume: 132x78x87 cm
 - Gross weight: 284 kg

Double Wood Shelves

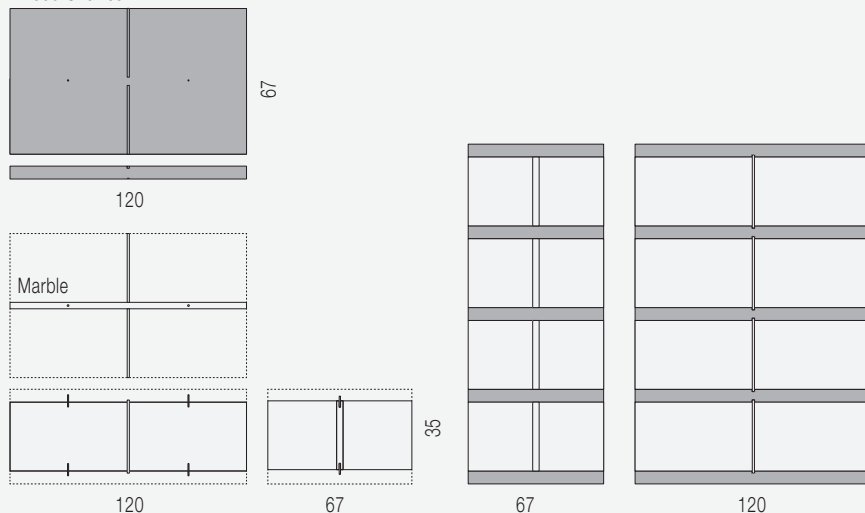

Marmo di fondo per / Supporting marble structure for

Marmo / Marble

- 2 piani / 2 shelves
- 3 piani / 3 shelves
- 4 piani / 4 shelves
- 5 piani / 5 shelves



Calacatta Carrara



Calacatta Classico

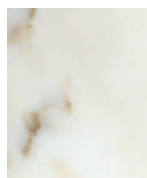

Bianco del Re



Bianco Carrara



Grigio St. Marie



Verde Ming

Marmo / Marble

- 2 piani / 2 shelves
- 3 piani / 3 shelves
- 4 piani / 4 shelves
- 5 piani / 5 shelves



Persian Grey

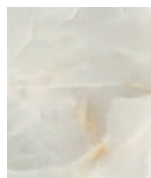

Onice Bianco



Cappuccino



Nero Marquina



Travertino Titanium



Verde Bamboo

Mensole / Shelves

Legno / Wood

- 2 piani / 2 shelves
- 3 piani / 3 shelves
- 4 piani / 4 shelves
- 5 piani / 5 shelves



Larice Bianco
White Larch



Noce Matt
Walnut Matt



Eucalipto Frisè
Eucalyptus Frisè

Tetris

Tetris 190

- Modello alto:
 - Peso netto: 12 Kg
 - Volume della cassa:
 194x120x112 cm
 - Peso lordo: 268 Kg
 - Weight: 12 kg
 - Volume of the crate:
 194x120x112 cm
 - Gross weight: 268 kg

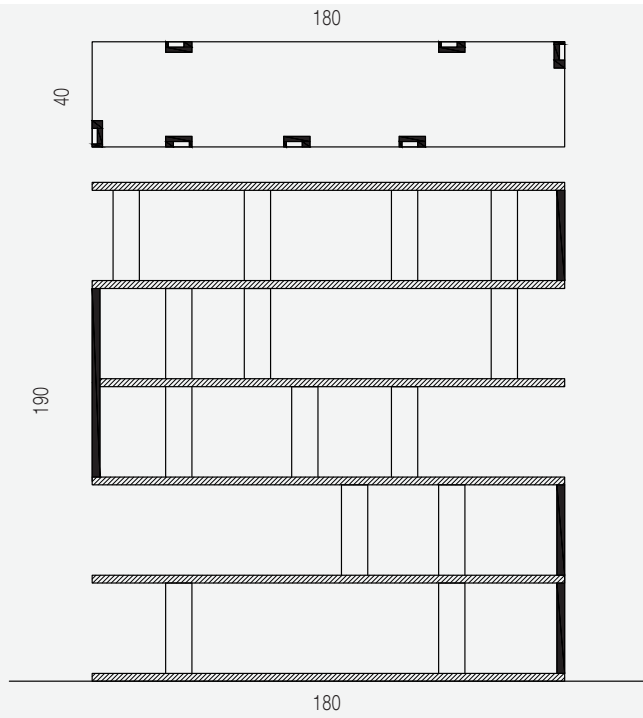
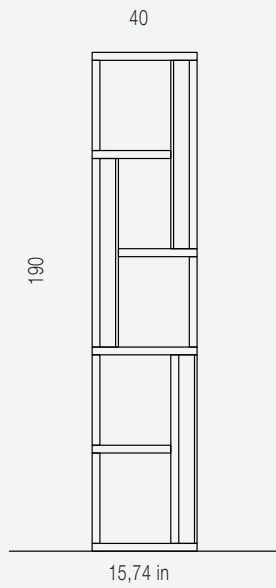

Tetris 75

- Modello basso:
 - Peso netto: 48 Kg
 - Volume della cassa:
 194x65x96 cm
 - Peso lordo: 115 Kg
 - Weight: 48 kg
 - Volume of the crate:
 194x65x96 cm
 - Gross weight: 115 kg

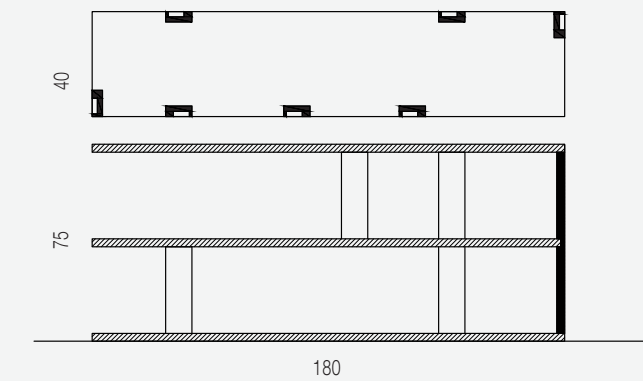
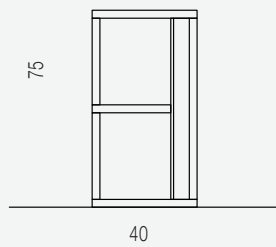

Marmo / Marble

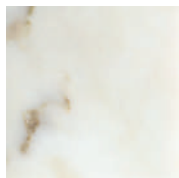

Bianco del Re



Calacatta Carrara



Verde Ming



Grigio St. Marie



Travertino Titanium



Silver Wave



Verde Bamboo

Legno / Wood

Tetris 190 cm
 Tetris 75 cm

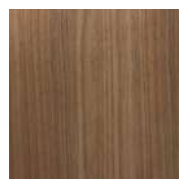

Noce Matt
 Walnut Matt



Larice Bianco
 White Larch

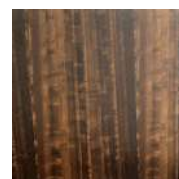

Eucalipto Frisè
 Eucalyptus Frisè

BATHROOM COLLECTIVE

- ROYAL S**
 - Peso netto: 12 kg
 - Volume della cassa: 45 x 45 x 65 cm
 - Peso lordo: 50 kg
 - Net weight: 12 kg
 - Crate volume: 45 x 45 x 65 cm
 - Net weight: 50 kg

- ROYAL M**
 - Peso netto: 14,5 kg
 - Volume della cassa: 60 x 60 x 58 cm
 - Peso lordo: 53 kg
 - Net weight: 14,5 kg
 - Crate volume: 60 x 60 x 58 cm
 - Gross weight: 53 kg

- ROYAL L**
 - Peso netto: 16,5 kg
 - Volume della cassa: 55 x 55 x 70 cm
 - Peso Lordo: 58 kg
 - Net weight: 16,5 kg
 - Crate volume: 55 x 55 x 70 cm
 - Gross weight: 58 kg

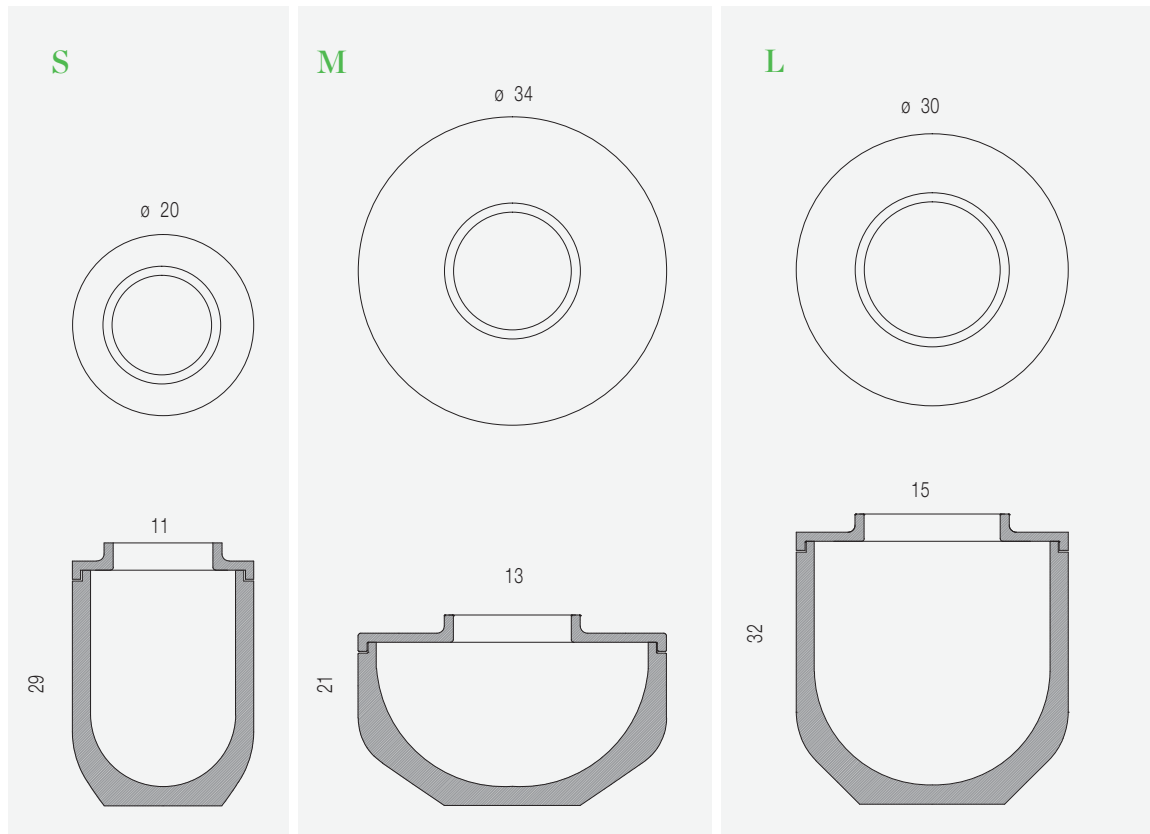

Marmo / Marble

- Royal S
 Royal M
 Royal L



Gris Cevenol



Artik Green

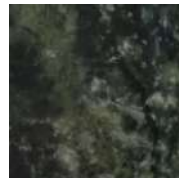

Verde Ming Scuro



Rosso Lepanto

- Spessore: 3,3 cm
- Peso netto modulo bassorilievo: 15 kg
- Thickness: 3,3 cm
- Bas-relief panel net weight: 15 kg

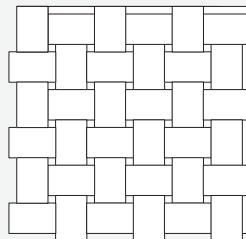

60

Colore sfondo / Color background

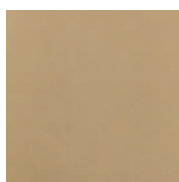

Bronzo Oro
Gold Bronze

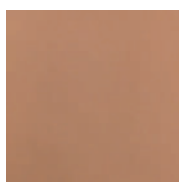

Bronzo Rosa
Pink Bronze

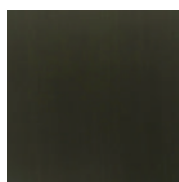

Bronzo Scuro
Dark Bronze

Prezzo al metro quadro / Price per square meter

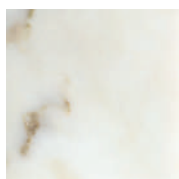

Bianco del Re



Calacatta Carrara



Bianco Carrara



Verde Ming



Grigio Bardiglio Light

€ 2.890,00

Marmo / Marble

Metallo

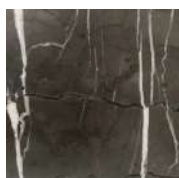

Persian Grey

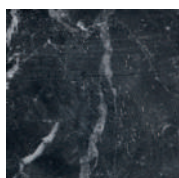

Nero Marquina

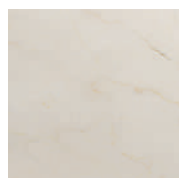

Crema Marfil

Marmo / Marble

Metallo

- Il prezzo è da intendersi complessivo di marmo e metallo.
- The price includes marble and metal.

- Spessore: 2 cm
- Peso netto modulo bassorilievo: 9 kg
- Thickness: 2 cm
- Bas-relief panel net weight: 9 kg

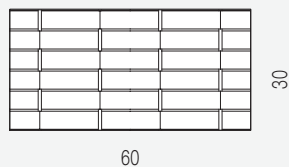

Colore inserti / Color inserts

Inserti / Inserts



Ottone
Brass

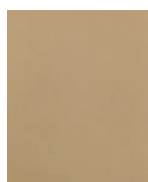

Bronzo Oro
Gold Bronze



Bronzo Rosa
Pink Bronze

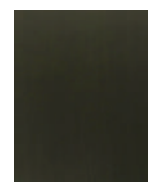

Bronzo Scuro
Dark Bronze



Acciaio
Steel

Prezzo al metro quadro / Price per square meter

Marmo / Marble

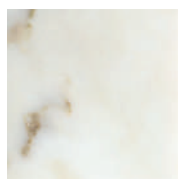

Bianco del Re



Calacatta Carrara

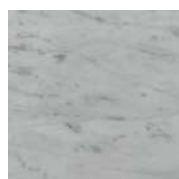

Bianco Carrara

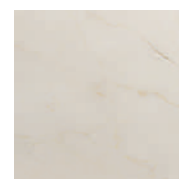

Crema Marfil



Verde Ming



Grigio Bardiglio Light

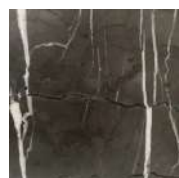

Persian Grey

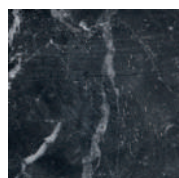

Nero Marquina

Ducale Collection

- Spessore: 2 cm
- Peso netto modulo bassorilievo: 20 kg
- Thickness: 2 cm
- Bas-relief panel net weight: 20 kg

Baguette

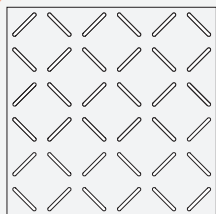

60

Ètoile



60

Carrè

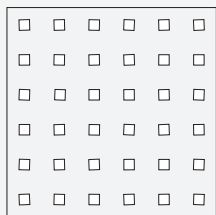

60

Pois

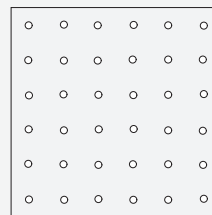

60

Prezzo al metro quadro /
Price per square meter

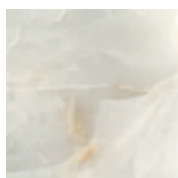

Onice Bianco Extra

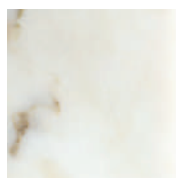

Bianco del Re



Calacatta Carrara

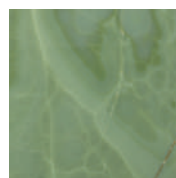

Onice Verde Extra



Onice Rosa

Marmo / Marble

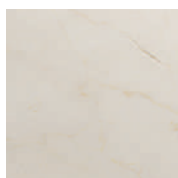

Crema Marfil



Verde Ming



Grigio Bardiglio Light

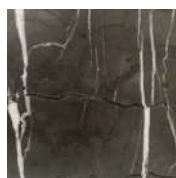

Persian Grey

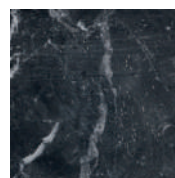

Nero Marquina

Marmo / Marble

Prezzo al metro quadro /
Price per square meter



Ottone
Brass



Oro
Gold



Mix 1 con Ottone
Mix 1 with Brass

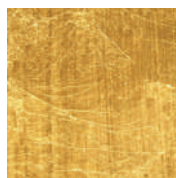

Mix 2 con Oro
Mix 2 with Gold

Decoro /
Decoration

Il prezzo va calcolato sommando marmo e decoro, indipendentemente dal modello scelto.
Pricing should be calculated adding stone and decoration, regardless of the chosen pattern.

BATHROOM COLLECTIVE

- Spessore: 2 cm
- Peso netto modulo bassorilievo: 20 kg
- Thickness: 2 cm
- Bas-relief panel net weight: 20 kg

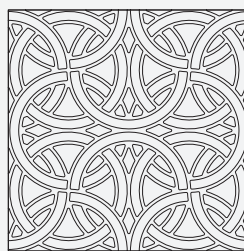

60

Prezzo al metro quadro /
Price per square meter

“A”

Marmo / Marble



Calacatta Carrara

“B”

Marmo / Marble

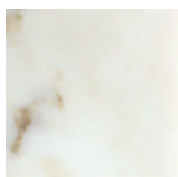

Bianco del Re



Bianco Carrara



Grigio St. Marie

“C”

Marmo / Marble



Travertino Noce

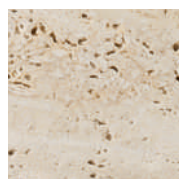

Travertino Paglierino

BASSORILIEVO /
BAS-RELIEF

“A”

“B”

“C”

GRAFFITI

“A+A”

“A+B” / “A+C”

“B+B” / “B+C” / “C+C”

BATHROOM COLLECTIVE

Merletto

- Spessore: 2 cm
- Peso netto modulo bassorilievo: 20 kg
- Thickness: 2 cm
- Bas-relief panel net weight: 20 kg

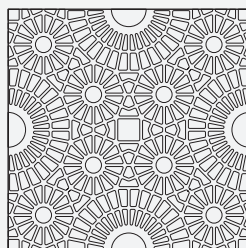

60

Prezzo al metro quadro /
Price per square meter

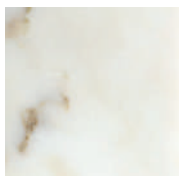

Bianco del Re



Calacatta Carrara

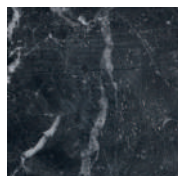

Nero Marquina



Bianco Carrara

Marmo / Marble

- Spessore: 2 cm
- Peso netto modulo bassorilievo: 20 kg
- Thickness: 2 cm
- Bas-relief panel net weight: 20 kg

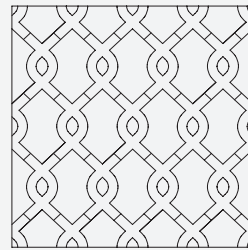

60

Prezzo al metro quadro /
Price per square meter

“A”

Marmo / Marble



Calacatta Carrara

“B”

Marmo / Marble

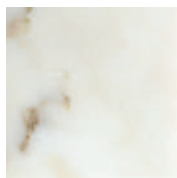

Bianco del Re

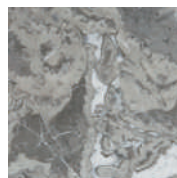

Grigio St Marie

“C”

Marmo / Marble

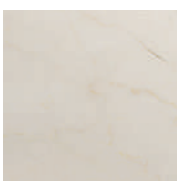

Crema Marfil

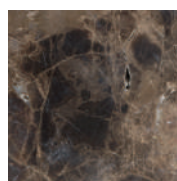

Emperador Dark

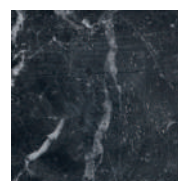

Nero Marquina

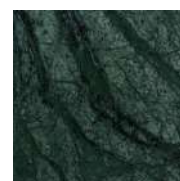

Verde Imperiale

BASSORILIEVO /
BAS-RELIEF

“A”

“B”

“C”

GRAFFITI

“A+A”

“A+B” / “A+C”

“B+B” / “B+C” / “C+C”

INTARSIO /
INLAY

“A+A”

“A+B” / “A+C”

“B+B” / “B+C” / “C+C”

BATHROOM COLLECTIVE

Weave

- Spessore: 2 cm
- Peso netto modulo bassorilievo: 20 kg
- Thickness: 2 cm
- Bas-relief panel net weight: 20 kg

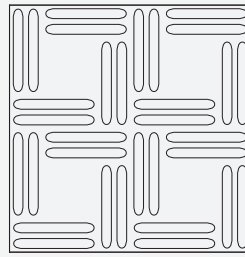

60

Prezzo al metro quadro /
Price per square meter

“A”

Marmo / Marble



Calacatta Carrara

“B”

Marmo / Marble

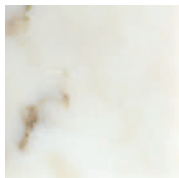

Bianco del Re

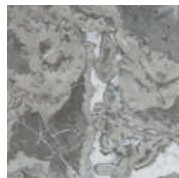

Grigio St Marie

“C”

Marmo / Marble

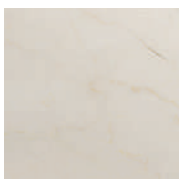

Crema Marfil

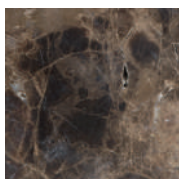

Emperador Dark

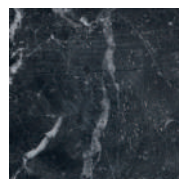

Nero Marquina

BASSORILIEVO /
BAS-RELIEF

“A”

“B”

“C”

GRAFFITI

“A+A”

“A+B” / “A+C”

“B+B” / “B+C” / “C+C”

INTARSIO /
INLAY

“A+A”

“A+B” / “A+C”

“B+B” / “B+C” / “C+C”

BATHROOM COLLECTIVE

- Spessore: 2 cm
- Peso netto modulo bassorilievo: 20 kg
- Thickness: 2 cm
- Bas-relief panel net weight: 20 kg

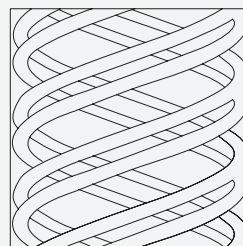

60

Prezzo al metro quadro /
Price per square meter

“A”

Marmo / Marble



Calacatta Carrara

“B”

Marmo / Marble

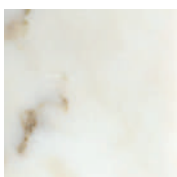

Bianco del Re

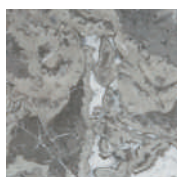

Grigio St Marie

“C”

Marmo / Marble

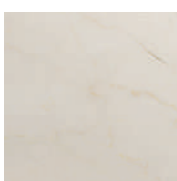

Crema Marfil



Grigio Bardiglio Light

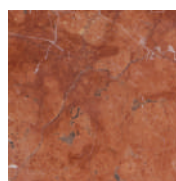

Rosso Alicante

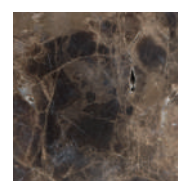

Emperador Dark

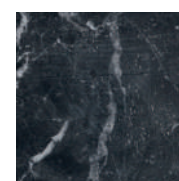

Nero Marquina

BASSORILIEVO /
BAS-RELIEF

“A”

“B”

“C”

GRAFFITI

“A+A”

“A+B” / “A+C”

“B+B” / “B+C” / “C+C”

INTARSIO /
INLAY

“A+A”

“A+B” / “A+C”

“B+B” / “B+C” / “C+C”

BATHROOM COLLECTIVE

Stone City

- Spessore: 2 cm
- Peso netto modulo bassorilievo: 20 kg
- Thickness: 2 cm
- Bas-relief panel net weight: 20 kg

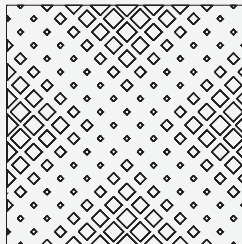

60

Prezzo al metro quadro /
Price per square meter

Basso rilievo /
Bas-Relief

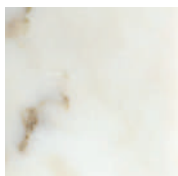

Bianco del Re



Grigio Bardiglio Light

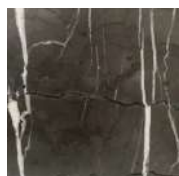

Persian Grey

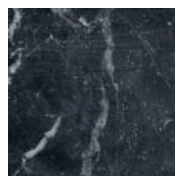

Nero Marquina

Marmo / Marble

Prezzi validi per ordinativi minimi di 10 Mq. Per ordini inferiori: +20%

Price are valid for orders of 10 SQMT minimum. For lower quantity orders, please consider an upcharge of + 20% on the price reported.

BATHROOM COLLECTIVE

- Spessore: 2 cm
- Peso netto modulo bassorilievo: 20 kg
- Thickness: 2 cm
- Bas-relief panel net weight: 20 kg

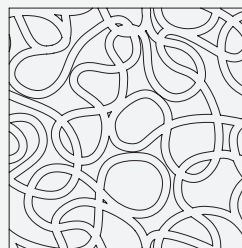

60

Prezzo al metro quadro /
Price per square meter

“A”

Marmo / Marble



Calacatta Carrara

“B”

Marmo / Marble

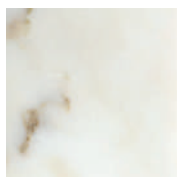

Bianco del Re

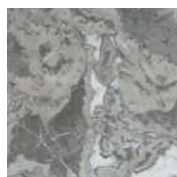

Grigio St Marie

“C”

Marmo / Marble

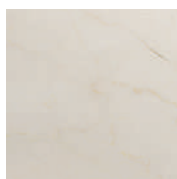

Crema Marfil



Rosso Alicante

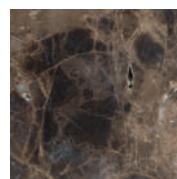

Emperador Dark

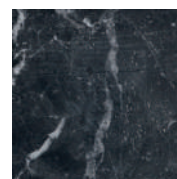

Nero Marquina

BASSORILIEVO /
BAS-RELIEF

“A”

“B”

“C”

GRAFFITI

“A+A”

“A+B” / “A+C”

“B+B” / “B+C” / “C+C”

INTARSIO /
INLAY

“A+A”

“A+B” / “A+C”

“B+B” / “B+C” / “C+C”

BATHROOM COLLECTIVE

Rose

- Spessore: 2 cm
- Peso netto modulo bassorilievo: 20 kg
- Thickness: 2 cm
- Bas-relief panel net weight: 20 kg



80

Prezzo al metro quadro /
Price per square meter

“A”

Marmo / Marble



Calacatta Carrara



Verde Ming

“B”

Marmo / Marble

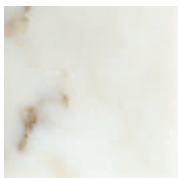

Bianco del Re

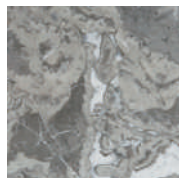

Grigio St Marie

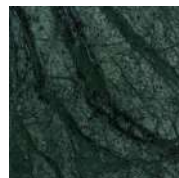

Verde Imperiale

“C”

Marmo / Marble



Bianco Perla

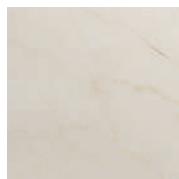

Crema Marfil

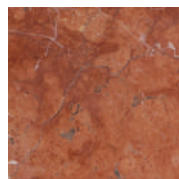

Rosso Alicante

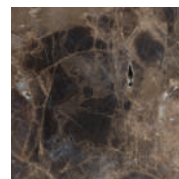

Emperador Dark

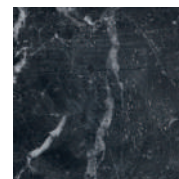

Nero Marquina

BASSORILIEVO /
BAS-RELIEF

“A”

“B”

“C”

GRAFFITI

“A+A”

“A+B” / “A+C”

“B+B” / “B+C” / “C+C”

INTARSIO /
INLAY

“A+A”

“A+B” / “A+C”

“B+B” / “B+C” / “C+C”

BATHROOM COLLECTIVE

100

- Spessore: 2 cm
- Peso netto modulo bassorilievo: 20 kg
- Thickness: 2 cm
- Bas-relief panel net weight: 20 kg

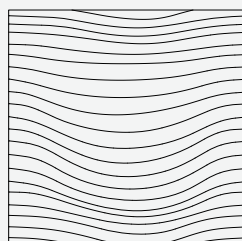

60

Prezzo al metro quadro /
Price per square meter

Basso rilievo /
Bas-Relief

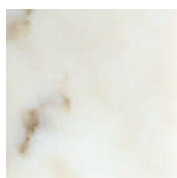

Bianco del Re

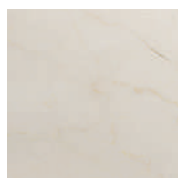

Crema Marfil



Travertino Navona



Travertino Titanium

Marmo / *Marble*

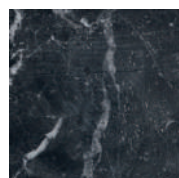

Nero Marquina

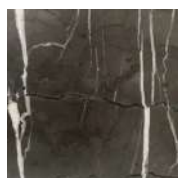

Persian Grey

Marmo / *Marble*

Prezzi validi per ordinativi minimi di 10 Mq. Per ordini inferiori: +20%

Price are valid for orders of 10 SQMT minimum. For lower quantity orders, please consider an upcharge of + 20% on the price reported.

BATHROOM COLLECTIVE

- Spessore: 2 cm
- Peso netto modulo bassorilievo: 20 kg
- Thickness: 2 cm
- Bas-relief panel net weight: 20 kg

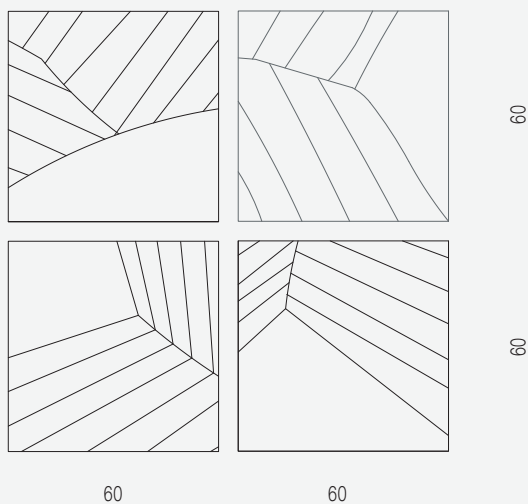

Prezzo al metro quadro /
Price per square meter

Marmo / Marble

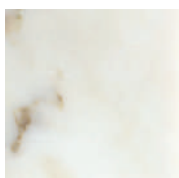

Bianco del Re



Travertino Navona



Travertino Noce

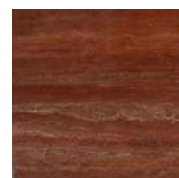

Travertino Rosso

Marmo / Marble

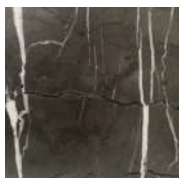

Persian Grey

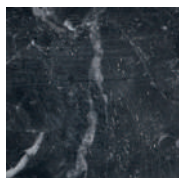

Nero Marquina



Travertino Titanium

Prezzi validi per ordinativi minimi di 10 Mq. Per ordini inferiori: +20%

Price are valid for orders of 10 SQMT minimum. For lower quantity orders, please consider an upcharge of + 20% on the price reported.

BATHROOM COLLECTIVE

CONDIZIONI DI VENDITA

PIETRA NATURALE: Unicità e autenticità

Ogni marmo, pietra e granito ha delle specificità uniche, le cui caratteristiche si sono plasmate nel corso dei millenni grazie ad elementi naturali, che conferiscono al vostro spazio di vita un'originalità senza eguali. È inoltre possibile creare qualsiasi cosa da ogni lastra o blocco senza limiti di forma e dimensione.

1. Caratteristiche estetiche

- 1.1 ogni singolo prodotto è di origine naturale con un carattere diverso da lastra a lastra che porta con sé una sua unicità, irriproducibile e non prevedibile.
- 1.2 Le tolleranze cromatiche e di variazioni di venature sono molto ampie e non uguali al campione ricevuto. Di conseguenza, differenze di tono e venature tra campione e fornitura sono da considerarsi naturali e caratteristiche intrinseche del prodotto.
- 1.3 Presenza di microporosità così come quella di sbrecciature sono da considerarsi caratteristiche del prodotto.
- 1.4 Eventuali porosità di diametro superiore a 1,5 / 2 mm potranno essere stuccate se richieste in fase di preventivo.
- 1.5 Prima della spedizione del materiale verrà inviata una foto del collaudo del prodotto, una volta accettata ci sarà impossibile prendere in considerazione un'eventuale modifica e/o contestazione.

2. Lavorazioni e finiture

- 2.1. La finitura lucida è da intendersi con un leggerissimo bisello. La richiesta dell'assenza di bisello va comunicata espressamente alla conferma d'ordine.
- 2.2 I pavimenti lucidi vanno preferibilmente rilucidati in opera da un posatore professionista.
- 2.3 Nel caso di una finitura di anticatura, ottenuta mediante un procedimento brevettato che va ad eliminare le parti più deboli del marmo permettendone anche la successiva spazzolatura a superficie ondulata e opaca senza perdere in luminosità, può provocare delle rotture o sbrecciature che rientrano nelle caratteristiche di questo tipo di finitura.
- 2.4 Lavorazione a massello:
 - 2.4.1. I nostri prodotti vengono ricavati, tramite lavorazioni artigianali, da interi blocchi di pietra.
 - 2.4.2. Ogni singolo pezzo può presentare venature, differenze di tonalità, intrusioni minerali, avvallature, stuccature dovute a caratteristiche naturali del marmo. Tali caratteristiche sono la conferma dell'utilizzo di materiali naturali non prevedibili e non contestabili.

3. Caratteristiche tecniche

- 3.1. trattandosi di un materiale naturale, la superficie tende ad assorbire. Va segnalata la richiesta di trattamento con idro oleorepellenti prima della fornitura.
- 3.2 Nel caso di richiesta di una superficie antiscivolo va richiesta e quotata in fase di preventivazione. Tale trattamento renderà la superficie ruvida e opaca.
- 3.3 Tolleranza sulle misure e sugli spessori +/- 2 mm
- 3.4 Tutti i nostri intarsi presentano uno spessore di 2 cm ottenuto mediante la soluzione 1+1 cm: i pezzi che compongono il disegno, aventi spessore 1 cm, vengono incollati su una lastra anch'essa a spessore 1 cm, per garantire una maggior tenuta durante la rilucidatura in opera e una migliore durabilità nel tempo.
- 3.5 Le palette dovranno essere custodite in luogo asciutto e protetto

4. Prezzi

- 4.1 Dercormarmi: tutti i prezzi e le quantità verranno verificati durante lo sviluppo dei disegni esecutivi
- 4.2 Kreoo: Le collezioni rappresentano un sistema modulare che permette infinite combinazioni. Le marmette verranno quindi fornite a moduli interi, da adattare sul posto ad opera di un posatore professionista. Eventuali richieste su misura verranno considerate fuori standard e il prezzo verrà comunicato di volta in volta.
- 4.3 I prezzi sono esclusi
 - 4.3.1. IVA e tasse
 - 4.3.2 Trasporto
 - 4.3.3 Posa
 - 4.3.4 Pilette, sifoni

5. Conferma d'ordine

- 5.1 L'ordine si intende confermato nel momento in cui viene ricevuto l'acconto della fornitura.
- 5.2 Assieme all'acconto dovrà essere firmata l'offerta, i disegni esecutivi e le foto dei materiali scelti

6. Imballo

- 6.1. Realizzato in gabbie/casse in legno, il materiale è opportunamente fissato internamente con polistirolo e regge in plastica.
- 6.2. Se sono richieste casse fumigate, deve essere espressamente indicato alla conferma dell'ordine.
- 6.3. le casse non sono sovrapponibili, non vanno effettuati trasbordi
- 6.4. L'imballaggio è incluso nel prezzo di vendita.

7. Spedizione

- 7.1 La spedizione non è inclusa nel prezzo di vendita. È possibile richiedere una quotazione al nostro customer service.
- 7.2 Nel caso di richiesta del trasporto, verrà addebitato il costo del servizio. ATTENZIONE non incluso:
 - 7.2.2 Operazioni di scarico sul cantiere, la merce verrà consegnata a bordo strada all'indirizzo concordato
 - 7.2.3 Da indicare se in cantiere c'è la presenza di un muletto o se sarà necessario un camion con sponda idraulica.
 - 7.2.4 Data e orario di scarico dovranno essere concordate direttamente dal cliente finale con il trasportatore
 - 7.2.5 Eventuali danni derivati da operazioni di scarico non adeguate non saranno a noi imputabili.
- 7.3 Il ritiro della merce ordinata deve avvenire entro e non oltre 4 settimane dal collaudo. Oltre tale data:
 - 7.3.1. non è garantita l'integrità del materiale
 - 7.3.2. Verranno addebitati i costi di magazzinaggio

8. Pagamenti

- 8.1 L'avvio della produzione del materiale avviene al momento della conferma dell'ordine attraverso il versamento dell'acconto concordato.
- 8.2 Qualora il cliente decida di recedere dal contratto di acquisto, ufficializzato con il pagamento dell'anticipo, ciò dovrà avvenire entro 5 giorni lavorativi per iscritto e parte dei costi sostenuti per la messa in produzione del materiale verrà trattenuto.

9. Posa

- 9.2 La posa del materiale è esclusa. Eventuali danni o contestazioni derivanti da erroneo stoccaggio del materiale, preparazione dei sottofondi, modalità di posa e installazione non saranno imputabili a Decormarmi e Kreoo

10. Contestazioni

- 10.2 La contestazione va segnalata per iscritto entro 8 giorni dal ricevimento della merce, allegando le foto delle casse al loro arrivo in cantiere e durante il procedimento di apertura. Ogni elemento danneggiato deve essere necessariamente fotografato dentro al proprio imballo.

11. Usura e invecchiamento del materiale

- 11.2 Tutti i prodotti sono realizzati con materiali naturali. Nel tempo, questi materiali saranno influenzati e soggetti alle variabili intrinseche del contesto ambientale in cui verranno installati. Questi cambiamenti sono considerati come previsti e normali risultati della natura di ciascun materiale. non è responsabile per l'usura ragionevole di materiali naturali. Rivendicazioni di usura straordinarie possono essere presentate per la sostituzione entro sei mesi dalla consegna, a discrezione del team.

12. Sviluppo disegni esecutivi

- 12.1 Il servizio relativo allo sviluppo dei disegni esecutivi è completamente gratuito per le prime tre revisioni. Prima di procedere con la produzione del materiale sarà necessario confermare il disegno scelto.
- 12.1 Ogni eventuale revisione eccedente le prime tre prevede un costo aggiuntivo che verrà aggiunto al prezzo del preventivo e comunicato di volta in volta.

13. Collaudo del materiale

- 13.1 ogni ordine fino a 30 m2, prima dell'invio verrà ispezionato e fotografato gratuitamente per essere accettato
- 13.2 nel caso in cui la quantità sia superiore a 30 m2 verrà fotografata una superficie pari almeno al 20% del materiale rappresentativa dell'intera fornitura.
- 13.3. nel caso in cui la quantità sia superiore a 30 m2 e venga richiesta una foto dell'intera fornitura, il costo verrà addebitato.

14. Fornitura serie Living e Bagno collezione Kreoo

- 14.1 Si tratta di prodotti realizzati artigianalmente usando legno massello di larice; ogni fessurazione o crepa del legno è da ritenersi un valore aggiunto e non un difetto, poiché si tratta di un materiale vivo e soggetto alle variazioni climatiche ambientali.
- 14.2 Nel caso in cui gli oggetti Kreoo vengano posizionati all'esterno dovrà essere effettuata una manutenzione del legno ogni 6 mesi con prodotti adeguati e una copertura degli oggetti nei mesi più freddi dell'anno, e da un'eccessiva esposizione ai raggi del sole.
- 14.3 la presenza di intarsi in ottone richiede una manutenzione frequente con pulizia dell'ottone con prodotti adeguati, non toccando la parte di marmo del prodotto che va protetto.

BATHROOM COLLECTIVE

SALES CONDITIONS

NATURAL STONE: *Uniqueness and authenticity*

Marble, stone and granite have unique features, whose essence have been shaped over the millennia, thanks to a natural geological process. This uniqueness gives your living space an unmatched originality.

1. AESTHETIC FEATURES

- 1.1 Every single product is of natural origin, with different features from slab to slab, bringing unique, irreproducible and unpredictable features.
- 1.2 The color and grain variation tolerances are very wide and not always strictly represented by the samples provided. Consequently, differences in tone and veins, between the samples and the actual supply are meant to be considered natural and intrinsic peculiarities of the product.
- 1.3 Presence of micro-porosities, as well as that of natural cracks, are to be considered features of the product.
- 1.4 Any porosity with a diameter greater than 1.5 / 2 mm may be grouted, if requested during the estimate phase.
- 1.5 Before the packaging of any marble good, a set of photo of the products inspection will be shared and, once accepted, it will be impossible to take into consideration any modification and/or dispute and claim.

2. FABRICATION AND FINISH

- 2.1. The glossy and polished finish is provided with a very light bevel. The request for the absence of bevel must be expressly communicated into the order confirmation.
- 2.2 Polished floors should preferably be ultimately polished on site, by a professional installer.
- 2.3 In case of honed finish, please be aware this is achieved through a patented process that eliminates the weakest marble parts, and then the surface is properly brushed. In this way, marble gets an old-fashioned effect, with a wavy and matt surface that reproduces exactly the effect of a natural wearing effect of time, without losing its vibrant brightness. The particular manufacturing of these products can lead to some breaks or chips that cannot be contestable.
- 2.4 Solid carving:
 - 2.4.1. Our products are obtained, through craftsmanship cut, from entire blocks of stone.
 - 2.4.2. Each single piece can present veins, differences in shades, mineral intrusions, depressions, grouting due to the natural characteristics of the marble. These features are confirmation of the use of natural material, therefore not a matter of claim.

3. TECHNICAL FEATURES

- 3.1. Being a natural material, the stone tends to absorb. The request of using a hydro / oil repellent treatment must be specifically demanded before the start of fabrication.
- 3.2 In case of an anti-slip surface request, make sure this is expressly written into the bidding phase and order description. This treatment will make the surface rough and opaque.
- 3.3 Size tolerance on sizes and thickness +/- 2 mm +/- 2 mm
The thickness of all our inlays is 2 cm and it is achieved by a 1+1 solution: the pieces that compose the pattern, which are 1 cm thick, are glued on a slab, which is 1 cm thick too, in order to get a better endurance during the re-polishing on site and a longer durability.
- 3.4 Crates must be stored in a roofed and covered place.

4. PRICES

- 4.1 Decormarmi: all prices and quantities will be verified during the development of the shop drawings.
- 4.2 Kreoo: the collection is composed by a modular system, able to create infinite combinations. For this reason, tiles are provided in modules requiring to be adapted on site, by a professional installer. Any customized requests will be considered non-standard and their price will be calculated separately.
- 4.3 Prices DON'T include
 - 4.3.1. VAT and taxes;
 - 4.3.2 Transportation fee ;
 - 4.3.3 Installation ;
 - 4.3.4 Drain, syphons and/or any plumbing feature.

5. ORDER CONFIRMATION

- 5.1 The order is considered confirmed when the deposit payment is received.
- 5.2 The offer, shop drawings and pictures will be additional confirmations to be processed at the moment of order confirmation.

6. PACKAGE

- 6.1. Package is performed in wood crates. The goods are properly fastened with plastic hooks and protected by layers of polystyrene on the inside.
- 6.2. If fumigate crates are required, this has to be expressly indicated in the confirmation of the order.
- 6.3. Our crates must not be overlapped and no transfers should be done.

6.4. Package fee is included into our sales prices.

7. SHIPMENT

7.1 Shipment is not included into our pricing. It's always possible to demand for a price to our customer service, during the whole process.

7.2 In the event of a request for transport, the cost of the transportation fee will be charged accordingly. ATTENTION: our standard procedure is EXW (ex-works).

Additional notes:

7.2.2 The goods will be delivered as a standard curbside delivery (no inside delivery).

7.2.3 Please indicate if the receiver will be equipped with forklift or if Decormarmi has to provide lift gate, at the moment of the final delivery.

7.2.4 Date and time arrival arrangements will be agreed by the final receiver and transportation company directly.

7.2.5 Damages caused by improper unloading procedures cannot be contestable and imputable to Decormarmi.

7.2.6 The pickup of inspected orders cannot be longer than 4 weeks by the moment of order readiness. After that date Decormarmi cannot guarantee material integrity and will charge for storage fees.

8. PAYMENTS

8.1 The start of fabrication will begin at the moment of order confirmation and the reception of the deposit payment.

8.2 In case the client will decide to withdraw from the purchase contract, having already made the payment of the deposit, this communication will take place within 5 working days in writing from client's end. Part of the costs incurred for the start of production of the material will be retained by Decormarmi.

9. INSTALLATION

Installation cost and service are excluded. Decormarmi will not accept liability nor reimbursement of damages related to improper installation or wrong storage, preparation of the backing, nor any installation procedures out of strict Decormarmi' scope.

10. CLAIMS

Any claim should be submitted by 8 days from the moment of goods reception, sharing full photo set showing crates at the moment of their arrival and/or during their opening. Every damaged good must be photographed inside its original crate.

11. MATERIAL WEAR AND AGING

All Decormarmi products are crafted using natural materials. Over time, these materials will be impacted by and adjust to their environment. These changes are considered as expected and normal results of the nature of each material and are not defects. Decormarmi is not liable for reasonable wear of natural materials. Extraordinary wear claims may be submitted to Decormarmi for replacement within six months of delivery, subject to the discretion of Decormarmi team.

12. SHOP DRAWING DEVELOPMENT

Before proceeding to fabrication, shop drawing release and confirmation are needed.

12.1 The service of shop drawing release is completely free during the first (3) three reviews of the plans /drawings of the project's scope.

12.2 Should more revisions be required, Decormarmi will apply an additional cost related to any further necessary revision time by time.

13. SHOP DRAWING DEVELOPMENT

13.1 Every order containing less than 30 m2 of covering will be entirely photographed and subject to a normal confirmation process.

13.2 In case the quantity is above 30 m2 Decormarmi will be photographing 20% surface of the order' scope, representative of the overall quality.

13.3. In case the quantity is above 30 m2 and the client needs the full inspection of the surface, the cost of the full inspection will be charged to the client.

14. KREOO LIVING AND BATHROOM COLLECTIONS

14.1 Kreoo products are handcrafted pieces result of an artisanal process, made using solid larch wood; any split or fissure of the wood has to be considered an added value and not a defect, since this is natural material, therefore subject to weather and environmental conditions.

14.2 In case of an outdoor application of Kreoo wood products, Kreoo recommends a 6 months maintenance and care and an adequate covering cap during the coldest time of the year and roofed to protect the goods from solar rays.

14.3 Brass inlays require a continuous care and maintenance with adequate products, avoiding the marble parts adjacent to the metal inserts.

kreoo

