

BATHROOM COLLECTIVE

SUSSEX

SX

SX

When love
& skill work
together,
expect a
Masterpiece

John Ruskin

The Sussex story is a *family* adventure
to build an Australian business with
sustainability at its heart.

Because to us, we make more than
just taps. We create *timeless* objects of
beauty that carry the Sussex *spirit* out
into the world.

Inside

06

Sussex Spirit



20

Vision



21

Mission



12

Our Heritage



18

Art of Manufacturing



14

Australian From Start to Finish



22

Responsibility



32

Designer Finishes



COLLECTIONS



44

Calibre

62

Circa

80

Circa Vertex

94

Duct

112

Monsoon

126

Suba

148

Voda

We protect
what we
Love

With courage, conviction, and a good soul, we aim to achieve greatness. We create respect for Australian manufacturing, our products, our team, and our customers. When you choose the Sussex brand, you are not just buying for today but also for our future.

We are united in our determination to produce Australian-made products adhering to the highest ethical principles. You have our promise.



*Vanessa
& George*

Vanessa & George Katsanevakis
DIRECTORS

From father to daughter,
the story

Continues

The Sussex story is a family adventure to build an Australian business with sustainability at its heart. In 1960, our founder, Nicolaas Johannes van Putten, arrived in Australia with an idea and a talent for craftsmanship in watchmaking. When he took the next step in his career, he extended his obsession for craftsmanship into tapware. His vision was to make the best quality product — the sturdiest, most solid, and enduring tapware available — so that every piece in the collection would be made to last.

Now, more than 25 years after our first products were created, Nick's design engineering excellence still underpins every part of our process and is carried on today by his family as they continue to make timeless tapware crafted with soul.

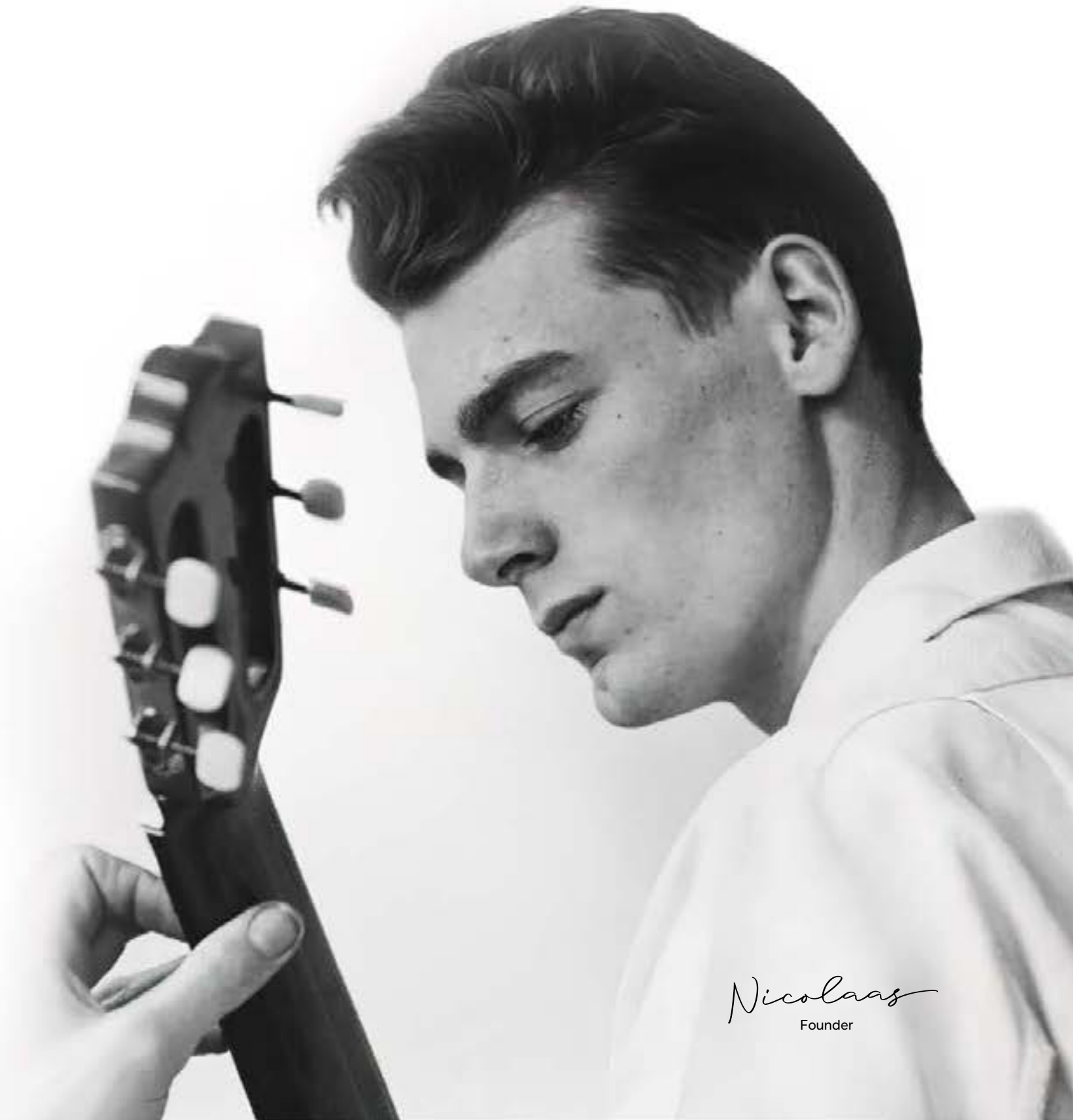

Nicolaas

Founder

Heritage

Australian From Start to Finish: A Path to *Perfection*

There are five key stages in the creation of a Sussex product. Countless steps are involved within each stage to guarantee the quality of each product until it's ready to become yours.

3 / Metal Finishing

Brilliance, shine, and colour are chosen and permanently set with thorough care and control using our metal polishing, electroplating, painting, and PVD processes.

1 / Design

Our in-house design team plays a crucial role in harmonising form and function in our products. They work closely with our engineers, production experts, and craftspeople.

4 / Assembly

No matter the level of complexity, our team maintains methodical practices to ensure the best quality and workmanship is delivered to every product.

2 / Manufacturing

To keep it all in-house we have three warehouses covering 6000 sq. meters to produce more than 500,000 components each year, entirely in Australia.

5 / Logistics

Dynamic teamwork needs to manage many moving parts for secure, accurate, and timely deliveries to our customers.

Perfect function and beautiful form have always been part of the Sussex *design* DNA

With sketches guided by vision that embrace the Sussex design philosophy, our designers take the first step on a long journey to turn those lines into a workable concept. They collaborate hand in hand with our engineering and architectural managers to create high-end collections for Australian homes. Every detail has been thoughtfully considered and obsessed over again and again.

SX

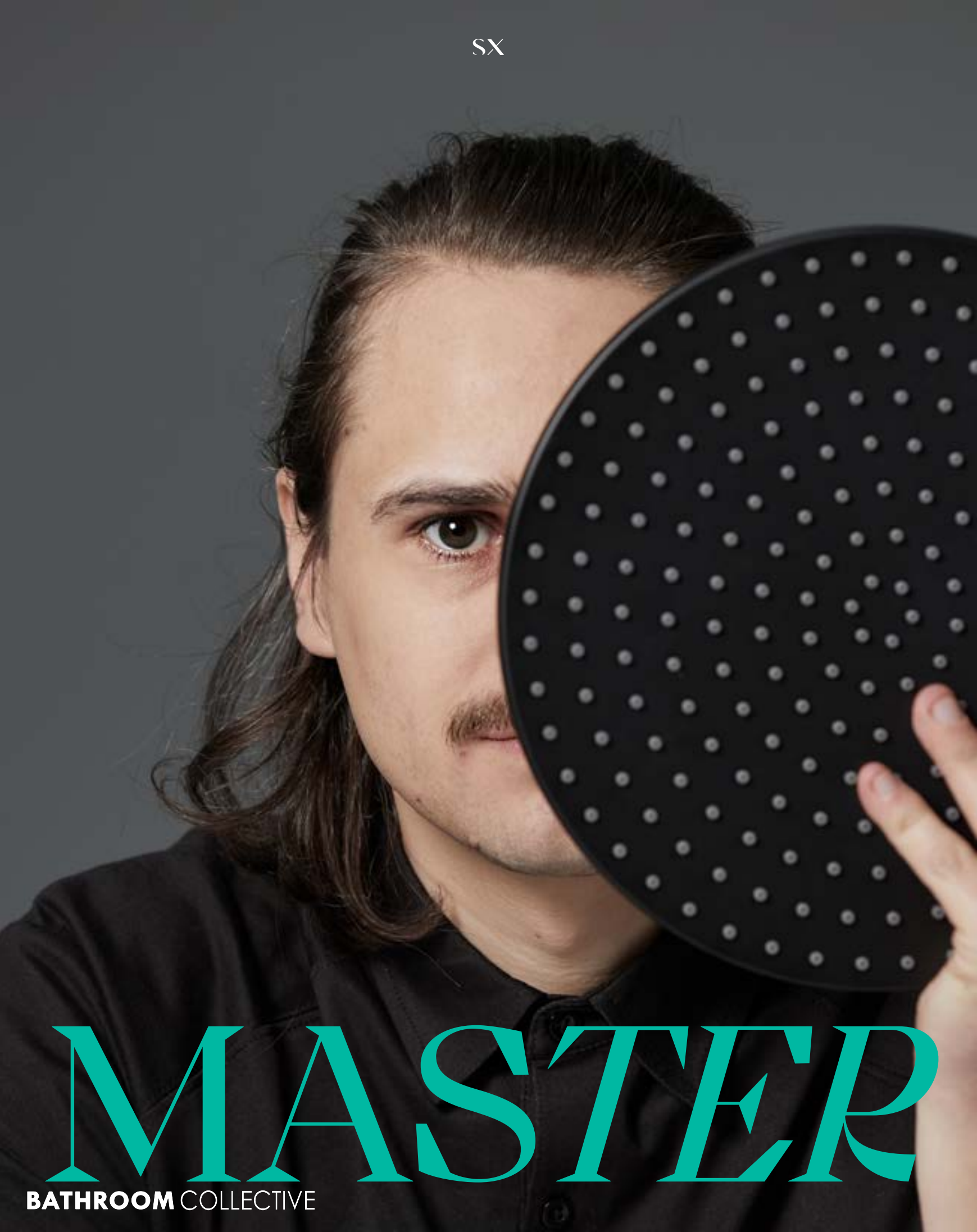

MASTER

BATHROOM COLLECTIVE

A decades-long journey
to master the art of
manufacturing.

Sussex has the coveted position of being vertically integrated entirely in Australia. Every product is created in-house: beginning with the vision of a collection to the casting in the foundry, all the way to the craftsman's workbench. The journey is completed using our LUXPVD® world-class finishing technology.



THE ART

The Collection
19

VISION

Make the best product and leave an Australian-made legacy which creates a sustainable future for our next generation.

MISSION

We pursue excellence at every level by embodying true craftsmanship, progressive technology, and best practice sustainability.

*Taking responsibility
is part of our DNA.*

30%

Reduction in
greenhouse gases

332

Tonnes of reduced emissions
through solar panel installation

100%

Recycling of our brass waste

ZERO

Net carbon emission from
2021 onwards

Reuse

Introducing a recycling program
for used tapware

100%

Efficient energy lighting installed
throughout

Making *it* ZERO

Australia's first carbon neutral
tapware manufacturer.

Our ambitious goal of transforming our manufacturing operation and all our products to reach net zero emissions hasn't been easy, but it was necessary. We are now officially a member of the Climate Active network, one of the strictest carbon neutral certification bodies in the world. This is because we're committed to making things right. Which means putting our future first by using sustainable technologies, sourcing raw metals, and designing and manufacturing our products entirely in Australia.

As a Climate Active member, we have achieved our products and organisation certification through Australia's most rigorous process and testing. Our customers can be sure they genuinely buy carbon-neutral products and contribute to positive climate action.

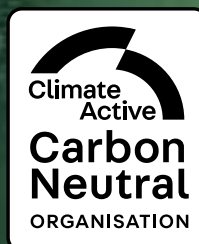

SX





LUXPVD®

*Perfect finishes
every single time.*

LUXURIOUS experience

Produced entirely in Australia, LUXPVD® technology gives us complete control of the finishing process, guaranteeing perfect colour and perfect tone every time.

UNIQUE finishes

All our LUXPVD® finishes are carefully curated, with flawlessly lustrous colour and unmatched tone for a consistent finish that is more sustainable and luxurious to the touch.

XTREME durability

LUXPVD® finishes are made for real living. It does not tarnish, corrode, or scratch easily, which is why we are proud to offer a 10-year extended warranty.



Our state-of-the-art
LUXPVD® facility.

From a technique pioneered for aerospace, Sussex has created LUXPVD®. A contamination-free process that is kind to the environment. Where metal vapour and vacuum combine to perfectly coat each and every tapware piece, every time, creating beautiful finishes that will stand the test of generations.

SX

Luxury

35

Finishes



Colour is intensely personal. That's why Sussex offers an extensive range of finishes to give your product the perfect finishing touch. Each is curated to complement our products' timeless designs. Infuse your personality in finishes from living brass, an organic brass that beautifully patinas with time; any of our timeless neutrals, offering warmth and elegance to every space; or one of our vibrant, sophisticated LUXPVD® finishes.

Once you explore our vast suite, you'll see why Sussex is synonymous with finishes in the Australian market.

Designer



LUXPVD®

From a technique pioneered for aerospace, Sussex has created LUXPVD®, a contamination-free process that is kind to the environment.

Where metal vapour and a vacuum combine to perfectly coat each and every tapware piece, every time, creating beautiful finishes that will stand the test of generations.

LUXPVD® finishes are robust, durable and hard-wearing that are suitable for all indoor applications.

Electroplated

Sussex electroplated finishes are robust, durable, and hard-wearing suitable for all indoor applications an everlasting finish that is corrosion-resistant and easy to clean.

Living

Sussex living finishes are raw (unsealed) metal surfaces that are designed to tarnish and patina in an inconsistent manner over time.

Time influences how this finish appears, and it can often darken to a rustic appearance.

Paint

Sussex painted finishes are similar to automotive paints that are designed to be wearable, durable and easy to clean.

When treated well and with regular maintenance, painted finishes can last for many years.

Stainless Steel

316 Marine-grade Stainless Steel is an unsealed, robust material designed for outdoor use, providing many years of usage in a wide range of environments.

As with any Stainless Steel products, exposure to hard water and/or coastal environments can cause "tea-staining" (surface discolouration).

SX

LUXPVD®

Designs
Finishes



LUXPVD®
Brushed Smoke Gunmetal



LUXPVD®
Matt Opium Black



LUXPVD®
Pure Gold



LUXPVD®
Brushed Pure Gold



LUXPVD®
Platinum Gold



LUXPVD®
Brushed Platinum Gold



LUXPVD®
Silk Rose Gold

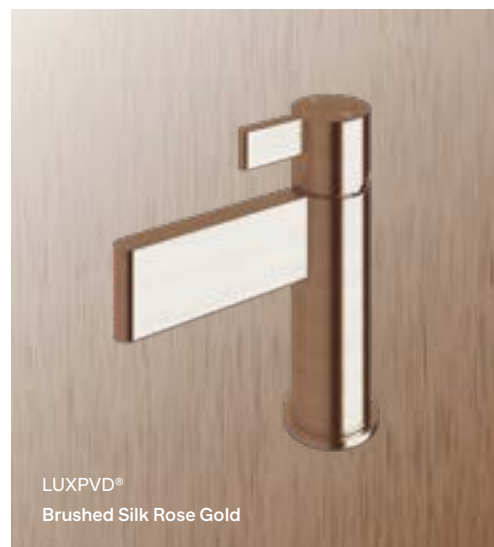

LUXPVD®
Brushed Silk Rose Gold



LUXPVD®
Brushed Rare Bronze



LUXPVD®
Brushed Oyster Nickel

Living

Designer
Finishes

Paint

Designer
Finishes

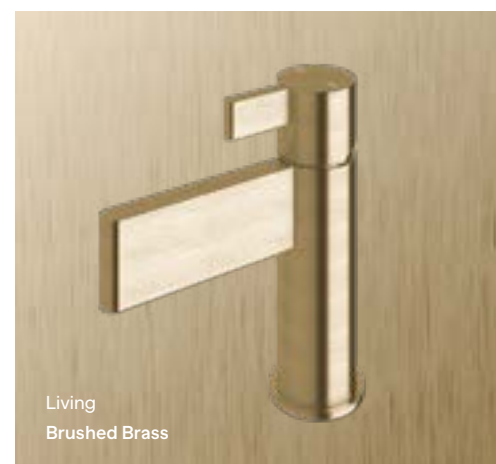

Electroplated

Designers
Finishes

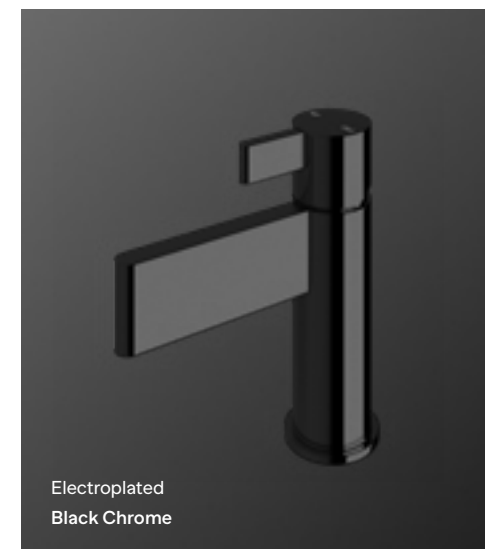

SX

COLLECTIONS

SX



Introducing

Calibre

Inspired by the sleek
lines and shapes found
in contemporary
architecture

*beautifully
bold*

SX

Absolute

Precision

We've been able to harness the power of our recycled brass to create the solid foundation for Calibre that will endure any level of use

Calibre tapsets, showers and outlets integrate with the range and share its modern aesthetic. A range of options means there's a perfect piece for your design.

BATHROOM COLLECTIVE

Calibre
Urban Chic

The Collection
47



Urban

CHIC

Sophisticated solutions
for a wide range
of architecturally
considered
environments

SX

Calibre
Urban Chic

Obsessed with

Perfection

Designed around
the simple, striking
combination of
balanced geometry
and perfected
proportions





1. Extended Basin Mixer



2. Basin Mixer



3. Wall Mixer



4. Diverter



5. Floor Mount Mixer With Hand Shower



6. Floor Mount Mixer Straight



7. Floor Mount Basin Mixer Straight

Mixers

The distinctive Calibre spout includes an elongated aerator. The spout's design is reflected in the simple lever handles, which add easy functionality to this popular mixer.

- 1. Extended Basin Mixer
5 star, 5 litres/min Δ
—
CEBM

- 2. Basin Mixer
5 star, 5 litres/min Δ
—
CBM

- 3. Wall Mixer
—
CWM

- 4. Diverter
—
CDIV

Floor Mount Mixers

The distinctive Calibre spout includes an elongated aerator. The spout's design is reflected in the simple lever handles, which add easy functionality to this popular mixer.

- 5. Floor Mount Mixer With Hand Shower
3 star, 8.5 litres/min (hand shower) Δ
—
CFMHST + SXFMMIK (Install Kit)

- 6. Floor Mount Mixer Straight
—
CFMST + SXFMMIK (Install Kit)

- 7. Floor Mount Basin Mixer Straight
5 star, 5 litres/min Δ
—
CFMBMST + SXFMMIK (Install Kit)



1. Vertical Shower
With Oval Head



2. Twin Rail Shower
With Oval Head

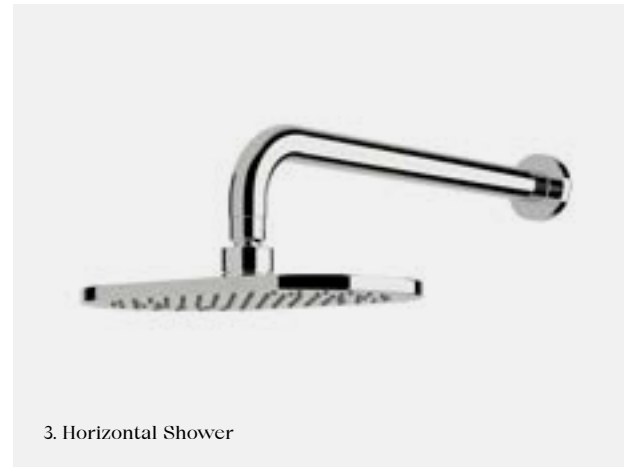

3. Horizontal Shower



4. Wall Basin/Bath Outlet



5. Wall Top Assembly



6. Wall Basin/Bath Set

Tapsets, Showers & Outlets

Calibre tapsets, showers and outlets integrate with the range and share its modern aesthetic. A range of options means there's a perfect piece for your design.

1. Vertical Shower With Oval Head

3 star, 8.5 litres/min Δ

—
300mm Arm Model
CVSH300
500mm Arm Model
CVSH500

2. Twin Rail Shower With Oval Head

Bottom inlet only available

3 star, 8 litres/min Δ

—
CTRS

3. Horizontal Shower

3 star, 8.5 litres/min Δ

—
CHSH

4. Wall Basin/Bath Outlet

5 star, 5 litres/min Δ

—
CWBO175
CWBO225

Non-restricted model

—
CBO175
CBO225

5. Wall Top Assembly

—
CWTA

6. Wall Basin/Bath Set

5 star, 5 litres/min Δ

—
CWBS175
CWBS225

Non-restricted model

—
CBS175
CBS225



1. Bath Mixer System With Hand Shower



2. Shower Mixer System



3. Wall Basin/Bath Mixer Outlet System



4. Dual Mixer System

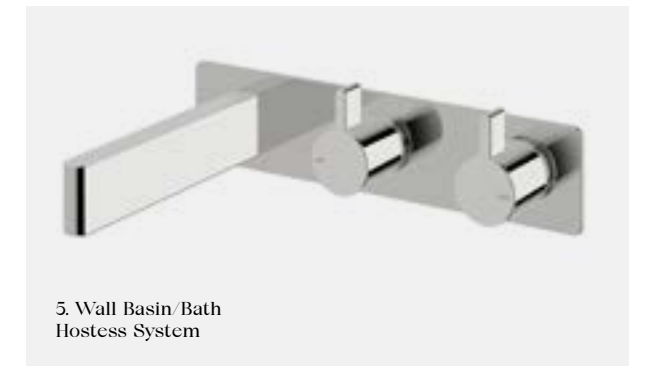

5. Wall Basin/Bath Hostess System



6. Mixer Diverter System



Mixer & Hostess Systems

Calibre mixer and hostess systems work in synergy with the entire Calibre collection. All feature the Sussex Masterfit system for ease of installation and a beautiful result.

1. Bath Mixer System With Hand Shower

RH and LH models available
3 star, 8.5 litres/min (hand shower) ∅

—
CBMS150RH
CBMS200RH

2. Shower Mixer System

3 star, 8.5 litres/min (hand shower) ∅

—
CSMS

3. Wall Basin/Bath Mixer Outlet System

RH and LH models available

5 star, 5 litres/min ∅

—
CWBMS150RH
CWBMS200RH

Non-restricted model

—
CMOS150RH
CMOS200RH

4. Dual Mixer System

—
CDMS

5. Wall Basin/Bath Hostess System

RH and LH models available

5 star, 5 litres/min ∅

—
CWBHS150RH
CWBHS200RH

Non-restricted model

—
CBHS150RH
CBHS200RH

6. Mixer Diverter System

RH and LH models available

—
CMD5RH

STYLE



Calibre
Extended Basin Mixer



Calibre
Wall Mixer
—
LIVING BRUSHED BRASS



Calibre
Basin Mixer
—
BRUSHED NICKEL



Calibre
Shower Mixer System
—
PURE GOLD

*Unified by purity of form
and strong elegant lines.*

Foundry

Even as new technologies are employed, the human touch remains critical

Julian
Foundryman



Our internal foundry is a key component in guaranteeing both the excellence of our manufacturing process and our commitment to long-term sustainability.

From the reused scraps to the ability to ensure the highest levels of purity, our process is a totally closed loop in the hands of our specialised foundrymen. With this rigorous process, we've been able to recycle our brass and create ethical, high-quality products. This method is integral to how we manufacture. It keeps our traditions alive and ensures nothing goes to waste.

"It's a unique experience to have complete control over quality."



SX



Introducing

Circa

Simple sophistication
in a singular pure
form: the circle

elegant

SX

Simply

Elegant

Circa's radial form brings to mind water's movement and its cyclical nature, while its overall design strength is created from its repetition of forms

Comprised of pure geometric shapes, Circa creates a strikingly simple statement from near or far.

BATHROOM COLLECTIVE





Perfect

LUXURY

Circa's design immerses any modern Australian space in style and luxury, providing a strikingly elegant centrepiece

SX

Obsessed with

Geometry

Comprised of pure
geometric shapes,
Circa creates a
strikingly simple
statement from
near or far





1. Basin Sink Hob Mixer Set



2. Basin Mixer



3. Wall Mixer



4. Hob Mixer



5. Floor Mount Mixer With Hand Shower



6. Floor Mount Mixer Curved



7. Floor Mount Basin Mixer

Mixers

Circa mixers combine elegance and simplicity, making each one a fine addition to any modern bathroom. The effortless style is matched by an ease of functionality.

1. Basin Sink Hob Mixer Set
5 star, 5 litres/min ∅
—
RBSHMS

2. Basin Mixer
5 star, 5 litres/min ∅
—
RBM

3. Wall Mixer
—
RWM

4. Hob Mixer
—
RHM

Floor Mount Mixers

Circa Floor mount mixers have a minimal, cylindrical form which makes each one a perfect addition to any fine bathroom. Their clean forms exude a modern luxury.

5. Floor Mount Mixer With Hand Shower
3 star, 8.5 litres/min (hand shower) ∅
—
RFMHT + SXFMMIK (Install Kit)

6. Floor Mount Mixer Curved
—
RFMCT + SXFMMIK (Install Kit)

7. Floor Mount Basin Mixer Curved
5 star, 5.5 litres/min ∅
—
RFMBMCT + SXFMMIK (Install Kit)



1. Vertical Shower
450mm



2. Horizontal Shower



3. Vertical Shower
120mm



4. Twin Rail Shower



5. Basin Sink High Set



7. Basin Sink High Outlet



6. Basin Set



8. Wall Basin/Bath Set



9. Basin Outlet



10. Wall Basin/Bath Outlet



11. Wall Top Assembly

Tapsets, Showers & Outlets

The perfectly rounded form of the Circa collection, each individually crafted in our workshop, ensures this timeless aesthetic can be carried across every part of your home.

1. Vertical Shower 450mm
3 star, 9 litres/min $\hat{\Delta}$
—
RVS450

2. Horizontal Shower
3 star, 8 litres/min $\hat{\Delta}$
—
RHSH

3. Vertical Shower 120mm
3 star, 9 litres/min $\hat{\Delta}$
—
RVS120

4. Twin Rail Shower
Top or Bottom inlet available
3 star, 8 litres/min $\hat{\Delta}$
—
RTRS

5. Basin Sink High Set
5 star, 5 litres/min $\hat{\Delta}$
—
RBSHS

6. Basin Set
5 star, 5 litres/min $\hat{\Delta}$
—
RBS

7. Basin Sink High Outlet
5 star, 5 litres/min $\hat{\Delta}$
—
RBSHO

8. Wall Basin/Bath Set
5 star, 5.5 litres/min $\hat{\Delta}$
—
RWBS150
RWBS200
RWBS250

Non-restricted model
—
RBS150
RBS200
RBS250

9. Basin Outlet
5 star, 5 litres/min $\hat{\Delta}$
—
RBO

10. Wall Basin/Bath Outlet
5 star, 5.5 litres/min $\hat{\Delta}$
—
RWBO150
RWBO200
RWBO250

Non-restricted model
—
RBO150
RBO200
RBO250

11. Wall Top Assembly
—
RWTA



1. Bath Mixer System With Hand Shower



2. Shower Mixer System



3. Wall Basin/Bath Mixer Outlet System



4. Dual Mixer System



5. Wall Basin/Bath Hostess System

Mixer & Hostess Systems

Circa mixer and hostess systems are a seamless fit with the Circa collection, and with Sussex Masterfit technology, its installation is simple to achieve in any setting.

1. Bath Mixer System With Hand Shower

RH and LH models available
3 star, 8.5 litres/min (hand shower) ∆

- RBMS150RH
- RBMS200RH
- RBMS250RH

2. Shower Mixer System

3 star, 8.5 litres/min (hand shower) ∆

— RSMS

Image: Kristian Van Der Beek

3. Wall Basin/Bath Mixer Outlet System

RH and LH models available

5 star, 5.5 litres/min ∆

- RWBMS150RH
- RWBMS200RH
- RWBMS250RH

Non-restricted model

- RMOS150RH
- RMOS200RH
- RMOS250RH

4. Dual Mixer System

— RDMS

5. Wall Basin/Bath Hostess System

5 star, 5.5 litres/min ∆

- RWBHS150RH
- RWBHS200RH
- RWBHS250RH

Non-restricted model

- RBHS150RH
- RBHS200RH
- RBHS250RH

STYLE



Circa
Twin Rail Shower



Circa
Basin Mixer Hob Mixer Set
—
LIVING TUMBLED BRASS



Circa
Basin Set
—
BRUSHED NICKEL



Circa
Wall Basin/Bath Mixer
Outlet System
—
BRUSHED NICKEL

*Simply elegant.
This minimalist statement
promises to elevate
your everyday.*

Design

Each collection is a result of our desire to simplify, and the passion of our master designers and engineers

Ashleigh
Lead Industrial Designer

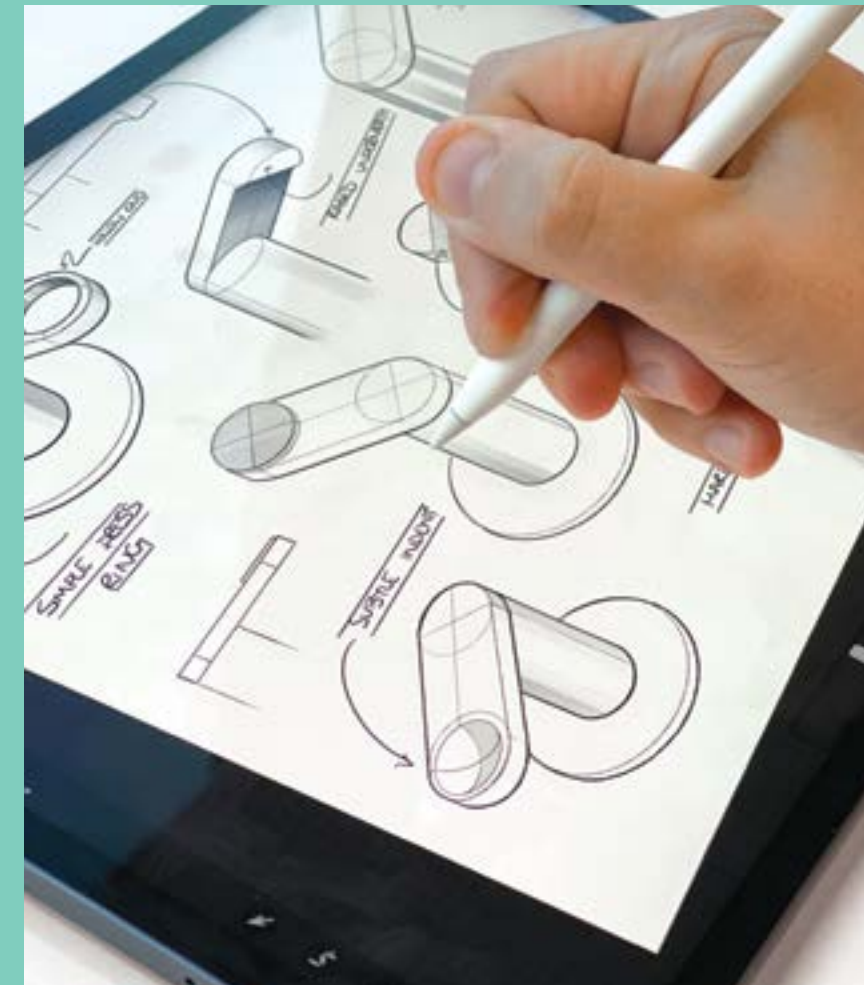

Our designers are always mindful of current tastes, but with one eye turned towards the future, they remain true to Sussex's heritage. This alchemy of the past, present, and future uniquely distinguishes the design of a Sussex tap.

Throughout the creative process, we look at design trends, usability studies, and market feedback to guide our designs. We then blend our passion for detail, decades of experience, ethical responsibility, and our unique spirit to create products that symbolise the essence of Sussex. This is the foundation of a product that is developed with both head and heart.

"It's about understanding people's needs and taking them on a journey."

SX



Introducing

Circa Vertex

Defined through its rounded form and modernist simplicity, Vertex sets itself apart by elegantly transforming the Circa handle

precision

SX

A touch of

Brilliance

The precisely milled channels capture light, reflecting it across the tapware surface and emitting a unique spectrum of hues and tones

A meticulous in-house machining technique that produces an exquisite textured surface, precisely engineered and milled to perfection.

BATHROOM COLLECTIVE



SX

Finishing

Touch

A finely tuned form
that is comfortable in
the hand, reassuring
to the touch, providing
effortless adjustment
wet or dry



1. Basin Sink Hob Mixer Set



2. Basin Mixer



3. Wall Mixer



4. Hob Mixer



5. Floor Mount Mixer With Hand Shower



6. Floor Mount Mixer Curved



7. Floor Mount Basin Mixer Curved

Mixers

Circa Vertex mixers combine elegance and simplicity, making each one a fine addition to any modern bathroom. The effortless style is matched by an ease of functionality.

1. Basin Sink Hob Mixer Set
5 star, 5 litres/min Δ
—
RBSHMS-V

2. Basin Mixer
5 star, 5 litres/min Δ
—
RBM-V

3. Wall Mixer
—
RWM-V

4. Hob Mixer
—
RHM-V

Floor Mount Mixers

Circa Vertex Floor mount mixers have a minimal, cylindrical form which makes each one a perfect addition to any fine bathroom. Their clean forms exude a modern luxury.

5. Floor Mount Mixer With Hand Shower
3 star, 8.5 litres/min (hand shower) Δ
—
RFMHT-V + SXFMMIK (Install Kit)

6. Floor Mount Mixer Curved
—
RFMCT-V + SXFMMIK (Install Kit)

7. Floor Mount Basin Mixer Curved
5 star, 5.5 litres/min Δ
—
RFMBMCT-V + SXFMMIK (Install Kit)



1. Basin Sink High Set



2. Basin Set



2. Basin Set
5 star, 5 litres/min $\hat{\circ}$
—
RBS-V



3. Wall Top Assembly



3. Wall Top Assembly
—
RWTA-V



3. Wall Basin/Bath Set

4. Wall Basin/Bath Set
5 star, 5.5 litres/min $\hat{\circ}$
—
RWBS150-V
RWBS200-V
RWBS250-V

Non-restricted model

RBS150-V
RBS200-V
RBS250-V

Tapsets

The perfectly rounded form of the Circa Vertex collection, each individually crafted in our workshop, ensures this timeless aesthetic can be carried across every part of your home.

1. Basin Sink High Set
5 star, 5 litres/min $\hat{\circ}$
—
RBSHS-V



1. Bath Mixer System
With Hand Shower



2. Shower
Mixer System



3. Wall Basin/Bath
Mixer Outlet System



4. Dual Mixer System



5. Wall Basin/Bath
Hostess System

Mixer & Hostess Systems

Circa Vertex mixer and hostess systems are a seamless fit with the Circa collection, and with Sussex Masterfit technology, its installation is simple to achieve in any setting.

1. Bath Mixer System With Hand Shower

RH and LH models available
3 star, 8.5 litres/min (hand shower) ∆

—
RBMS150RH-V
RBMS200RH-V
RBMS250RH-V

2. Shower Mixer System

3 star, 8.5 litres/min (hand shower) ∆

—
RSMS-V

3. Wall Basin/Bath Mixer Outlet System

RH and LH models available

5 star, 5.5 litres/min ∆

—
RWBMS150RH-V
RWBMS200RH-V
RWBMS250RH-V

Non-restricted model

—
RMOS150RH-V
RMOS200RH-V
RMOS250RH-V

4. Dual Mixer System

—
RDMS-V

5. Wall Basin/Bath Hostess System

5 star, 5.5 litres/min ∆

—
RWBHS150RH-V
RWBHS200RH-V
RWBHS250RH-V

Non-restricted model

—
RBHS150RH-V
RBHS200RH-V
RBHS250RH-V



Teresa
Product Specialist

Values

The Sussex Way –
Living by Our Values
Every Day

The Sussex Values are what we stand for and how we act towards one another. It's at the very core of who we are, defining our collective beliefs and guiding our individual actions. We can foster an environment that is respectful, inclusive, and diverse, where everyone is considered equal.

We recognise the power of individuals connected by values. Nothing at Sussex would be possible without the many remarkable people who continue to contribute their talents at every level.

"My main aim is
to make the
customer happy."



SX



Introducing

Duet

Inspired by the beauty
of duality: two ideas
collaborating to create
something larger and better
than themselves through
their mutual attraction

balance

SX

Perfect

Harmony

The perfect harmony
of form and experience.
Precision at every touch.

SX



Simple

FORMS

Two oval forms unite to provide a perfect ergonomic platform that allows for effortless adjustment of water temperature and flow

SX

Absolute

Perfection

Balancing the energy put into
a product whilst creating
a form that delivers optimal
efficiency at every touch





1. Sink Progressive Mixer Set Pull Out Spray

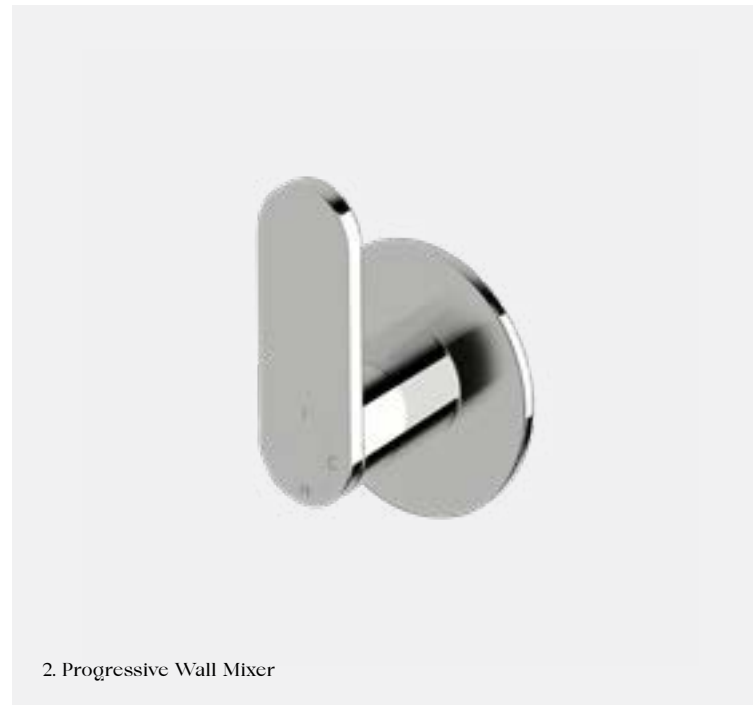

2. Progressive Wall Mixer



3. Progressive Top Mount Hob Mixer

Mixers

Duet mixers bring the collection's versatile form and unity to any contemporary bathroom design. The balanced curves of the mixers accentuate their straightforward functionality.

- 1. Sink Progressive Mixer Set Pull Out Spray
5 star, 5.5 litres/min ∅
—
DSPMSPOS

- 2. Progressive Wall Mixer
—
DPWM

- 3. Progressive Top Mount Hob Mixer
—
DPTMHM



1. Horizontal Shower



2. Shower Head Oval 250mm



3. Horizontal Shower Arm

Showers

The shower heads and accessories celebrate the relaxed rounded form of Duet. Its well-proportioned aesthetic is a beautiful example of perfected Sussex design.

- 1. Horizontal Shower
3 star, 8.5 litres/min ∅
—
DHSB

- 2. Shower Head Oval 250mm
3 star, 8.5 litres/min ∅
—
DHSB

- 3. Horizontal Shower Arm
—
DHSA



1. Basin Sink Hob Mixer Set High



2. Basin Sink Hob Mixer Set Low



3. Basin Set



4. Basin Sink High Set



5. Wall Top Assembly



6. Wall Basin/ Bath Set

Tapsets

Duet's tapsets are an effortless way to integrate the range's sleek aesthetic to your home. The variety of combinations provide endless opportunities that can match with any modern style.

1. Basin Sink Hob Mixer Set High

6 star, 4.5 litres/min Δ

DBSHMSH

2. Basin Sink Hob Mixer Set Low

5 star, 5 litres/min Δ

DBSHMSL

3. Basin Set

5 star, 5 litres/min Δ

DBS

4. Basin Sink High Set

6 star, 4.5 litres/min Δ

DBSHS

5. Wall Top Assembly

DWTA

6. Wall Basin/ Bath Set

6 star, 4.5 litres/min Δ

DWBS165

5 star, 5 litres/min Δ

DWBS200

Non-restricted model

DBS165
DBS200



1. Progressive Wall Basin/Bath Mixer System

Mixer Systems

The Duet mixer systems are a perfect way to bring the range's harmonious style to your home. Featuring the Sussex Masterfit system, they are easy to install and configure.

1. Progressive Wall Basin/Bath Mixer System

6 star, 4.5 litres/min Δ

—
DPWBMS165

5 star, 5 litres/min Δ

—
DPWBMS200

Non-restricted model

DPBMS165
DPBMS200

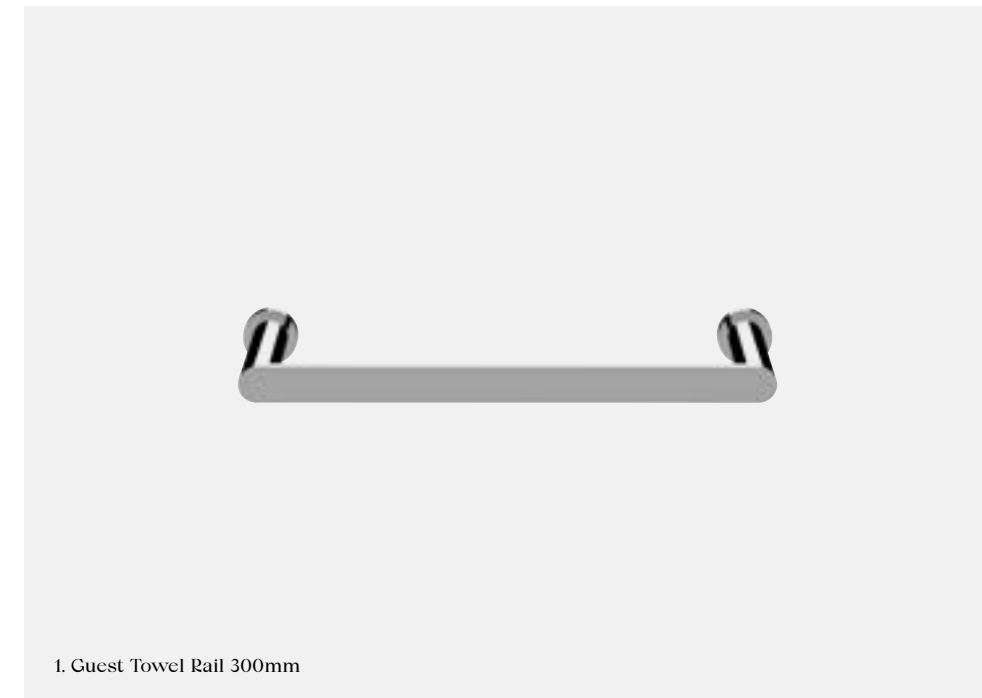

1. Guest Towel Rail 300mm



3. Toilet Roll Holder



2. Towel Rail 600mm

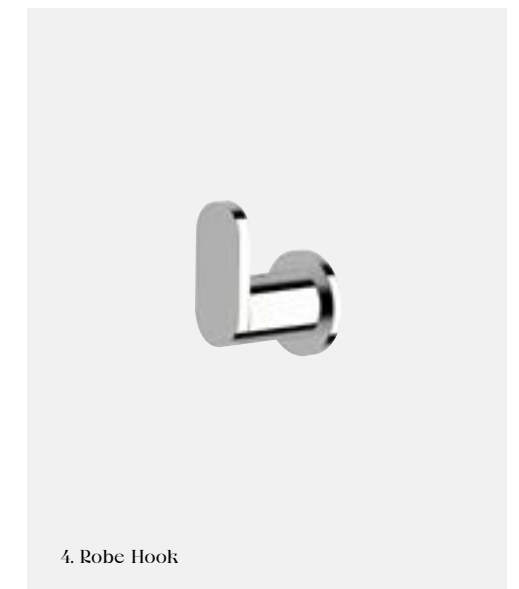

4. Robe Hook

Accessories

Enjoy Duet's rounded, balanced curves throughout your entire bathroom with the Duet range of accessories. They can complement the design or become moments of considered contrast.

1. Guest Towel Rail 300mm

—
DGTR300

2. Towel Rail 600mm

—
DTR600

3. Toilet Roll Holder

—
DTRH

4. Robe Hook

—
DRH

STYLE



Duct
Basin Sink Hob Mixer Set High



Duct
Basin Outlet

LUXPVD® BRUSHED PURE GOLD



Duct
Progressive Wall Basin Mixer System
LUXPVD® BRUSHED PURE GOLD

Duct lends its considered proportions to offer versatility and uncompromising functionality throughout your home.

Technology

We pursue excellence
by using technology
to strengthen our
traditional skills

The art of manufacturing is a long-term journey. For us, this means finding the balance between traditional techniques and the latest technology, as well as the determination to compete on the world stage while remaining entirely in Australia. That's why it's necessary to invest in modern technologies for our manufacturing. This standard is managed by well-trained and talented operators using the most modern and eco-friendly machines.

We are one of the very few companies in Australia to implement robotics to achieve high standards of polishing and to build an architecturally designed, state-of-the-art facility to house the world's best PVD finishing technology.

We're moving towards a fully automated process that ensures the precision and quality in the finishing of our products is perfect every time.

"That's the beauty of
our business: we can
make changes very
quickly."



Zoran
Product Development Manager

SX



Introducing

Monsoon

Immerse yourself
in nature

calming

Monsoon
Inspired by Nature

The Collection
113

SX

Reassuring

Solidness

A functional artistic sculpture that embodies Sussex's design and craftsmanship using our highest-quality material

Made from marine-grade stainless steel and featuring a welded single unit body in a mirror polish finish, Monsoon's form beautifully hints at the calming cascade it can release.

BATHROOM COLLECTIVE

Monsoon
Inspired by Nature

The Collection
115





Inspired by

NATURE

Perfect for any space
where the natural
environment is a focus,
Monsoon will blur the
lines between out and in

SX

Tropical

Inspiration

Monsoon's thoughtfully
engineered rainfall
shower head offers
a relaxing and
unparalleled shower
experience





1. Horizontal Shower



2. Shower Rose



3. Vertical Shower



4. Wall Mixer



5. Column Shower



Outdoor/Indoor Showers

Monsoon combines aesthetic excellence and durability. Made from the very toughest 316 marine grade stainless steel, the range sets the new standard in Australian showers.

1. Horizontal Shower

3 star, 8.5 litres/min ∅

—
MSHAHSS

2. Shower Rose

3 star, 8.5 litres/min ∅

—
MSHR2SS

3. Vertical Shower

3 star, 8.5 litres/min ∅

300mm or 600mm
Arm available

—
MSHAVSS3
MSHAVSS6

4. Wall Mixer

—
MWMSS

5. Column Shower Hot/Cold

3 star, 8.5 litres/min ∅

—
MSHM500SS

Column Shower Cold available

3 star, 8.5 litres/min ∅

—
MSHM100SS

Image: John Downs

STYLE



Monsoon
Column Shower



Monsoon
Column Shower
—
316 STAINLESS STEEL



Monsoon
Column Shower Hot/Cold
—
316 STAINLESS STEEL



Monsoon
Vertical Shower with Wall Mixer
—
316 STAINLESS STEEL

*Inspired to invigorate
a space with nature's touch.
It's as if you have been caught
in a refreshing rainfall
- on purpose.*



Neil
Toolroom Manager

Craftmanship

Monsoon
Inspired by Nature

The Spirit of Sussex
runs through our
craftspeople



Our story of craftsmanship began over 60 years ago when our founder travelled from the Netherlands to start a business in Australia based on his talents for watchmaking. When he established Sussex in 1998, his intrinsic passion in traditional craftsmanship easily translated into tap making. That foundation of care and precision has been carried into the next generation, who continues his legacy of making timeless tapware crafted with soul.

"You have to
be very inventive,
keep thinking of
new ideas."

SX



Introducing

Suba

Modernist form
that's a work of art
in any space
bold

SX

Minimalist

Artistry

Created from the
exploration of boundaries
between minimalist
sculpture and practical
objects

The Suba collection is perfect for Australian modern living designs that require a sculptural touch. Designed to elevate your daily experience, these pieces will be statements for years to come.

BATHROOM COLLECTIVE



SX

Subtly

MODERN

The simplicity design reveals the dynamic attention to detail and genuine craftsmanship needed to create a functioning, beautiful work of art

SX

Visually

Crafted

Flat edges traverse
into subtle curves, a
confident geometric
statement that warms
to its space





1. Extended Basin Mixer



2. Basin Mixer



3. Wall Mixer



4. Diverter



5. Lever Extended Basin Mixer



6. Lever Basin Mixer



7. Lever Wall Mixer

Mixers

Suba mixers showcase the latest in architectural trends – the soft square. The sleek design works well in modern, minimalist settings. All elements are proportional in size.

1. Extended Basin Mixer
6 star, 3 litres/min Δ
—
BEBM85
BEBM125

2. Basin Mixer
6 star, 3 litres/min Δ
—
BBM

3. Wall Mixer
—
BWM

4. Diverter
—
BDIV

Lever Mixers

Suba lever mixers also provide you with the option of lever operation in the same soft square design and Sussex Masterfit compatibility.

5. Lever Extended Basin Mixer
6 star, 3 litres/min Δ
—
BLEBM85
BLEBM125

6. Lever Basin Mixer
6 star, 3 litres/min Δ
—
BLBM

7. Lever Wall Mixer
—
BLWM

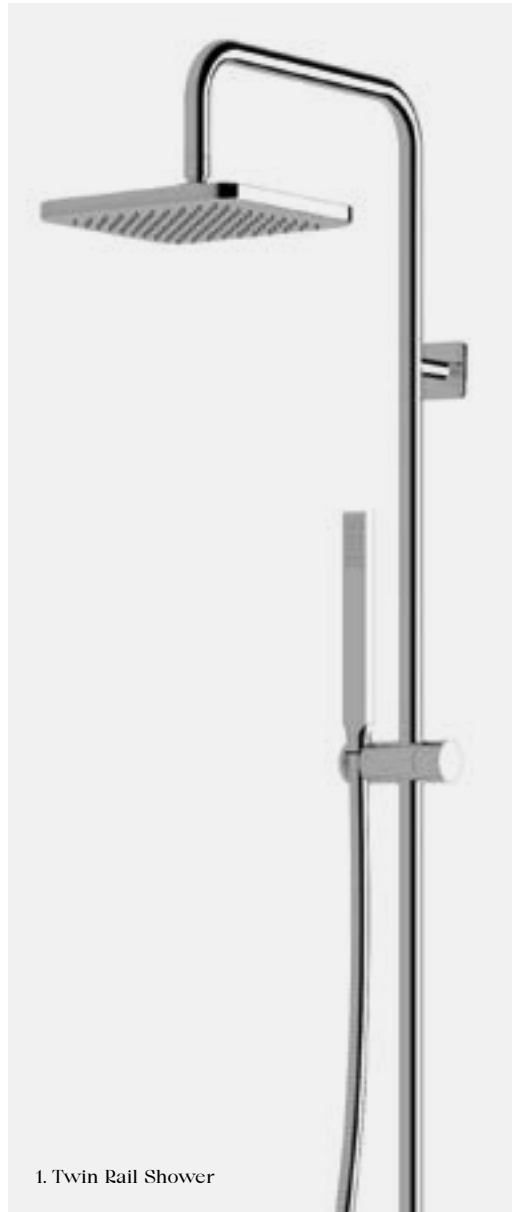

1. Twin Rail Shower



2. Hand Shower Supply Post Set



4. Vertical Shower



3. Horizontal Shower



4. Wall Top Assembly



4. Wall Top Assembly

—
BWTA



5. Wall Basin/Bath Outlet



5. Wall Basin/Bath Outlet

6 star, 3 litres/min ∅

—
BWBO160
BWBO210

Non-restricted model

—
BBAO160
BBAO210

Tapsets, Showers & Outlets

Suba tapsets, showers and outlets all feature the Suba signature square profiles with rounded corners. The stylish design and pleasing proportions suit minimalist settings.

1. Twin Rail Shower

Top or Bottom inlet available

3 star, 8 litres/min ∅

—
BTRS

2. Hand Shower Supply Post Set

3 star, 9 litres/min ∅

—
BHSSPS

3. Horizontal Shower

3 star, 8.5 litres/min ∅

—
BSH220

4. Vertical Shower

3 star, 8.5 litres/min ∅

—
300mm Arm Model
BVSH3-220
500mm Arm Model
BVSH5-220

4. Wall Top Assembly

—
BWTA

5. Wall Basin/Bath Outlet

6 star, 3 litres/min ∅

—
BWBO160
BWBO210

Non-restricted model

—
BBAO160
BBAO210



1. Bath Mixer System
With Hand Shower



2. Shower
Mixer System



3. Wall Basin/Bath
Mixer Outlet System



4. Dual Mixer System



5. Mixer Diverter
System

Mixer Systems

All Suba mixer systems feature Sussex Masterfit for straightforward installation. You can choose left hand, right hand or dual hand configurations.

1. Bath Mixer System With Hand Shower

RH and LH models available
3 star, 9 litres/min (hand shower) ◊

—
BBMS160RH
BBMS210RH

2. Shower Mixer System

3 star, 9 litres/min (hand shower) ◊

—
BSMS

3. Wall Basin/Bath Mixer Outlet System

RH, LH and vertical models available

6 star, 3 litres/min ◊

—
BWBMS160RH
BWBMS210RH

Non-restricted model

—
BMOS160RH
BMOS210RH

4. Dual Mixer System

—
BDMS

5. Mixer Diverter System

RH and LH models available

—
BMDSRH



1. Lever Bath Mixer System
With Hand Shower



2. Lever Shower
Mixer System



3. Lever Dual Mixer System



5. Lever Mixer Diverter System



4. Lever Wall Basin/Bath
Mixer Outlet System

Lever Mixer Systems

Suba lever mixer systems also provide you with the option of lever operation in the same soft square design and Sussex Masterfit compatibility.

1. Lever Bath Mixer System With Hand Shower

RH and LH models available
3 star, 9 litres/min (hand shower) ∅

—
BLBMS160RH
BLBMS210RH

2. Lever Shower Mixer System

3 star, 9 litres/min (hand shower) ∅

—
BLSMS

3. Lever Dual Mixer System

—
BLDMS

4. Lever Wall Basin/Bath Mixer Outlet System

RH, LH and vertical models available
6 star, 3 litres/min ∅

—
BLWBMS160RH
BLWBMS210RH

Non-restricted model

—
BLMOS160RH
BLMOS210RH

5. Lever Mixer Diverter System

RH and LH models available

—
BLMDSRH



1. Vanity Shelf



2. Shower Shelf



3. Soap Dish



4. Toothbrush Holder



5. Guest Towel Rail



8. Toilet Roll Holder

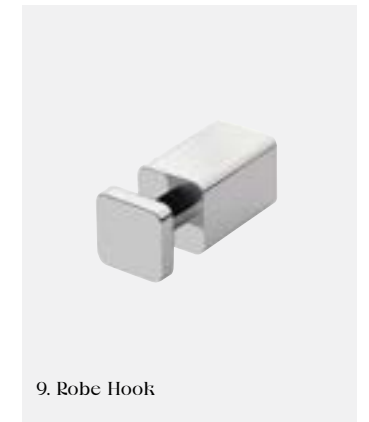

9. Robe Hook



6. Towel Rail Single



7. Towel Rail Double

Accessories

You can continue the Suba look across your entire bathroom. The Suba range of accessories is a perfect complement to your tapware with its soft square design.

1. Vanity Shelf

—
BVS

2. Shower Shelf

—
BSS

3. Soap Dish

—
BSD

4. Toothbrush Holder

—
BTBH

5. Guest Towel Rail

300mm

—
BGTR300

6. Towel Rail Single

700mm or 900mm

—
BTRS700
BTRS900

7. Towel Rail Double

700mm or 900mm

—
BTRD700
BTRD900

8. Toilet Roll Holder

—
BTRH

9. Robe Hook

—
BRH

STYLE



Suba
Shower Lever Mixer System
with Vertical Shower



Suba
Single Towel Rail
—
MATT OPIUM BLACK



Suba
Hand Shower Supply Post Set
—
MATT OPIUM BLACK



Suba
Basin Mixer
—
BRUSHED GOLD

Suba is bold. It emphasises the horizontal and vertical nature of the space, while simultaneously pulling attention towards itself.



Heidi
Production Coordinator

Journey

When an architect, interior designer, builder, or developer comes to us with their plans for an upcoming project, our Sussex manufacturing team knows that it's extremely important to understand all the details right from the start. We create strong relationships with our clients so we can be there at every stage, making your ideas reality.

"You need to do every step with excellence."



SX

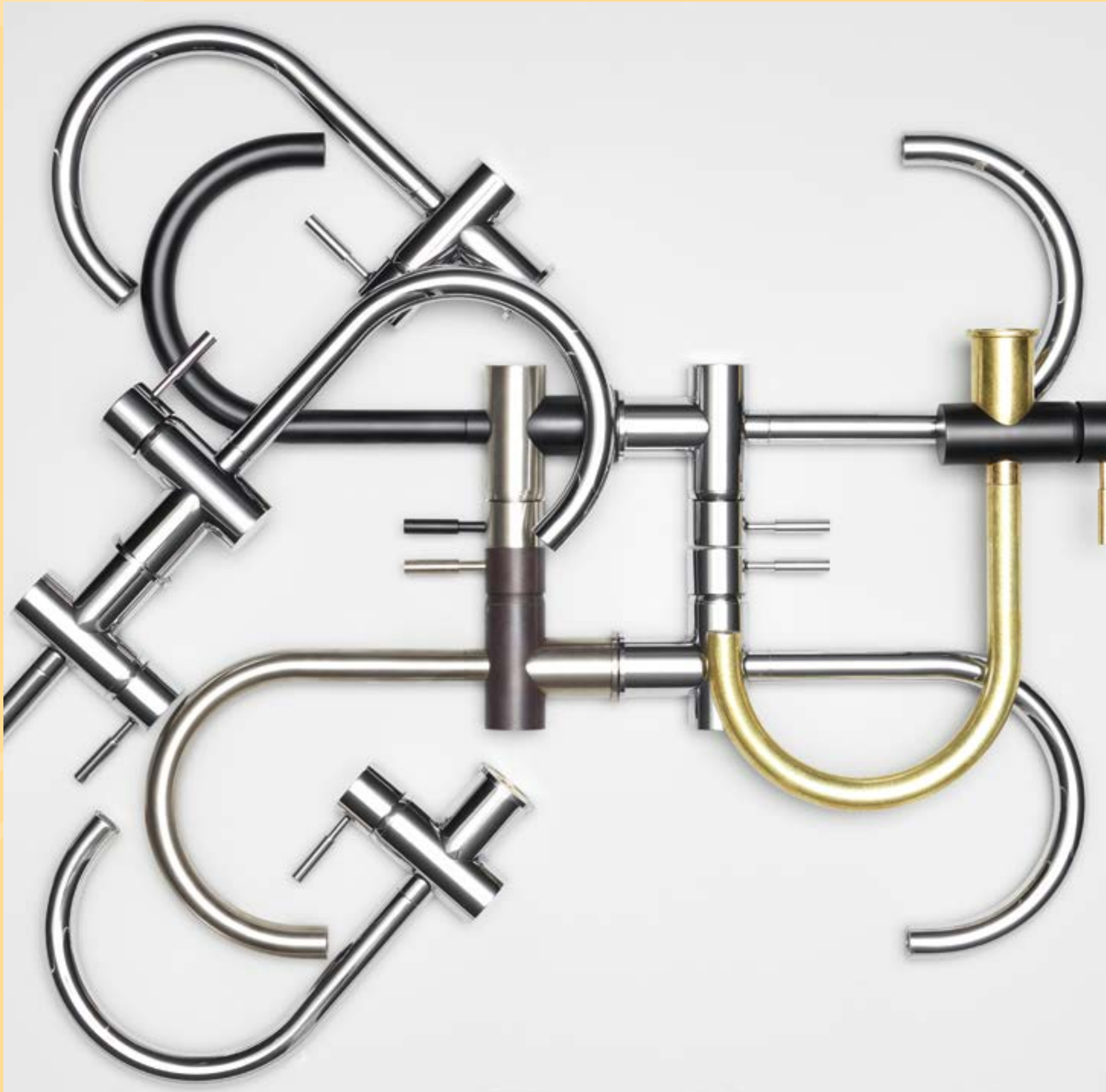

Introducing

Voda

Modernist style with a
minimalist touch

sophistication

SX

Modern

Refinement

The classic geometry and clean finishes weave together industrial modern style with simple and purposeful design

The idea of "form follows function," a principle associated with the modernist design movement, was the starting place for our Voda collection.

BATHROOM COLLECTIVE



Voda
Modern Refinement

The Collection
151

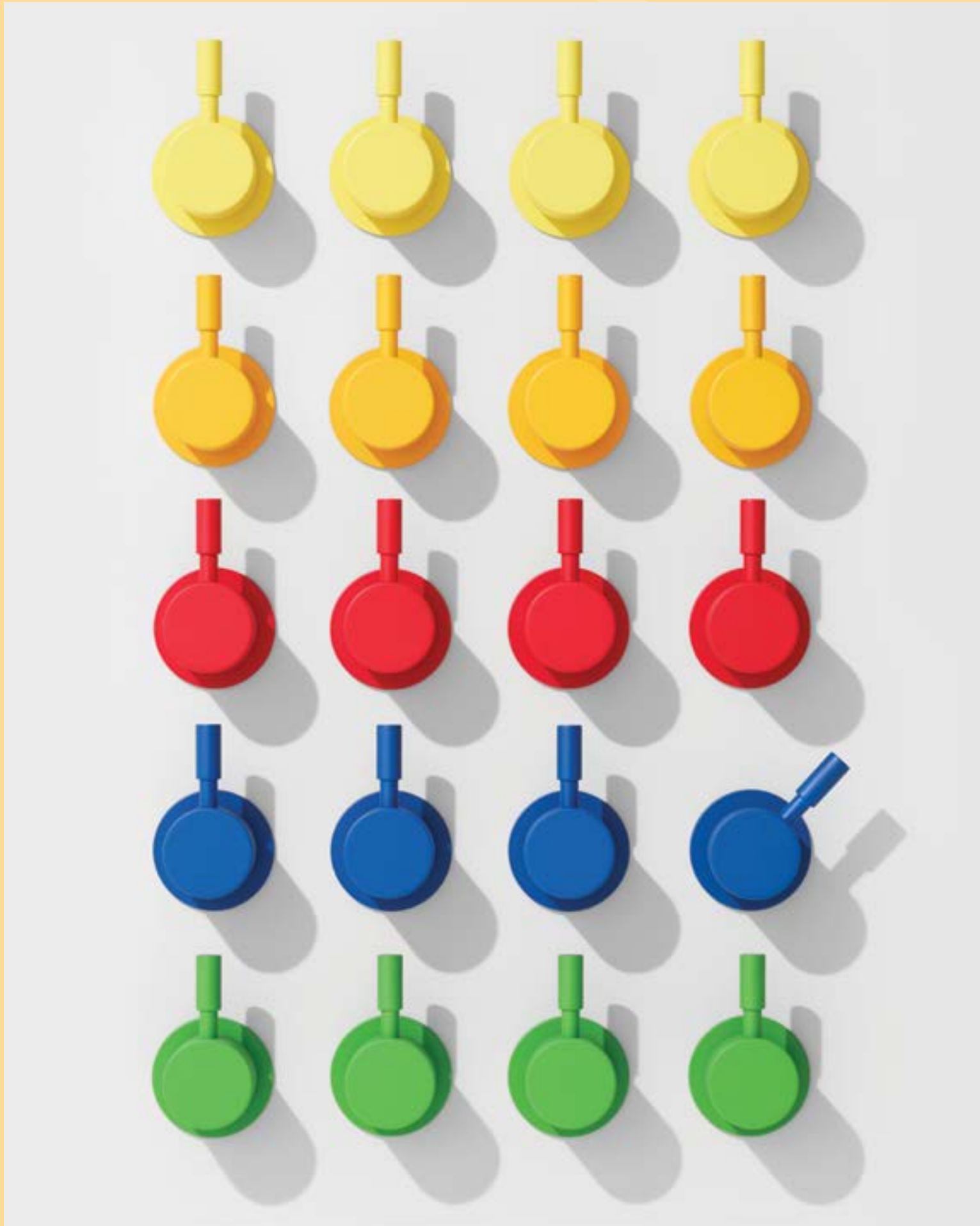

Modern

DESIGN

Voda celebrates pure aesthetic through its eye-pleasing geometric lines and the visual harmony of its shapes

SX

Voda
Modern Refinement

Perfect

Balance

Voda's pieces have an innate harmony that will complement any architectural design

The Collection
155



1. Sink Mixer Square
316 SS



2. Sink Mixer Curved
316 SS



3. Basin Mixer
316 SS



5. Wall Mixer
316 SS



4. Wall Top Assembly
316 SS

316 Stainless Steel Collection

Voda outdoor/indoor mixers epitomise quality. Made from 316 marine grade stainless steel, these taps will endure the harsh and varied Australian climate.

1. Sink Mixer Square 316 SS
RH and LH models available
4 star, 7.5 litres/min $\hat{\circ}$
—
VSMQSSRH

2. Sink Mixer Curved 316 SS
RH and LH models available
4 star, 7.5 litres/min $\hat{\circ}$
—
VSMCSSRH

3. Basin Mixer 316 SS
4 star, 7.5 litres/min $\hat{\circ}$
—
VBMSS

4. Wall Top Assembly 316 SS
—
VWTASS

5. Wall Mixer 316 SS
—
VWMSS



1. Sink Mixer With Pull Out



3. Sink Mixer Curved



2. Sink Mixer Square



4. Sink Mixer

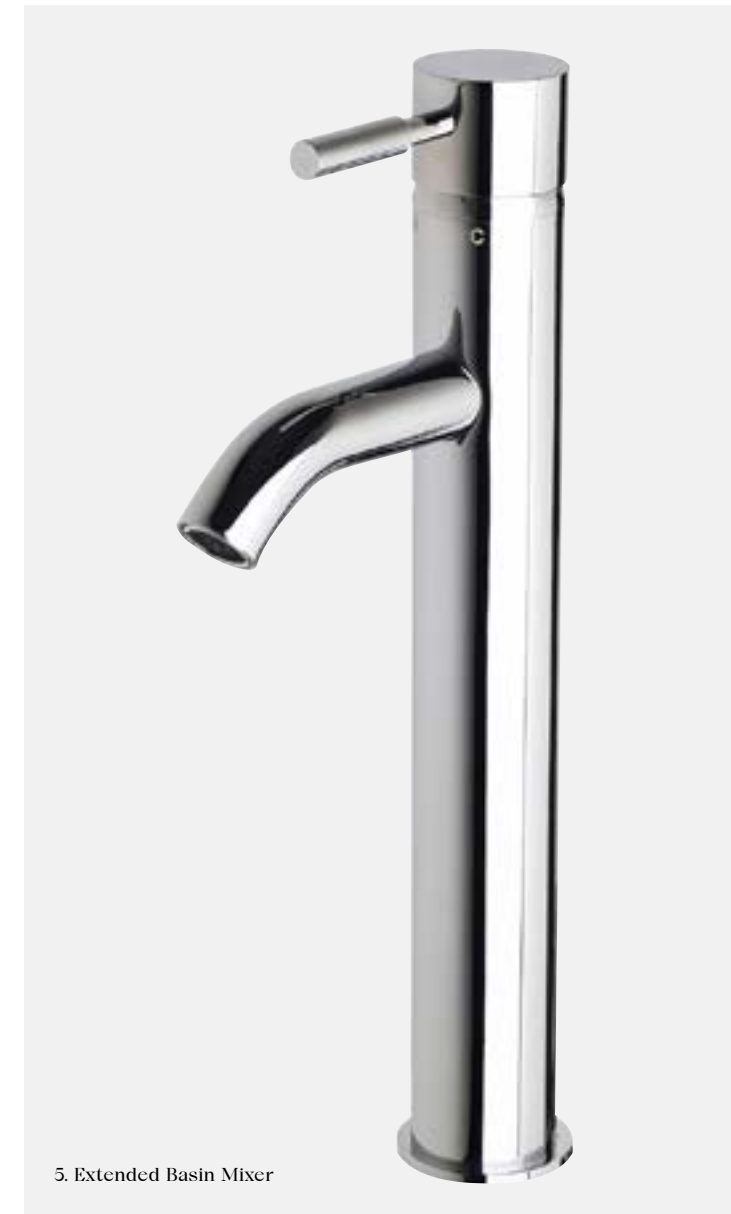

5. Extended Basin Mixer



6. Medium Basin Mixer



7. Basin Mixer

Mixers

Voda mixers combine a geometric design with a practical handle. The result is the perfect balance of form and function for your kitchen or bathroom.

1. Sink Mixer With Pull Out

4 star, 6.5 litres/min $\hat{\circ}$

—
VSMPO

2. Sink Mixer Square

RH and LH models available

4 star, 7.5 litres/min $\hat{\circ}$

—
VSMQ

3. Sink Mixer Curved

RH and LH models available

4 star, 7.5 litres/min $\hat{\circ}$

—
VSMC

4. Sink Mixer

RH and LH models available

4 star, 7.5 litres/min $\hat{\circ}$

—
VSM

5. Extended Basin Mixer

4 star, 7.5 litres/min $\hat{\circ}$

—
VEBM
VEBM120

6. Medium Basin Mixer

4 star, 7.5 litres/min $\hat{\circ}$

—
VMBM
VMBM120

7. Basin Mixer

4 star, 7.5 litres/min $\hat{\circ}$

—
VBM



1. Wall Mixer



3. Diverter



2. Hob Mixer



3. Diverter

—
VDIV

1. Wall Mixer

—
VWM

2. Hob Mixer

—
VHM



1. Floor Mount Mixer With Hand Shower

Floor Mount Mixers

Voda floor mount mixers bring a sense of sophisticated simplicity with their tall, elegant forms. The cylindrical profile is minimal and modern.

1. Floor Mount Mixer With Hand Shower

3 star, 8.5 litres/min (hand shower) ∅

—
VFMHT + SXFMMIK (Install Kit)



2. Floor Mount Bath Mixer Curved



3. Floor Mount Basin Mixer



4. Floor Mount Basin Mixer

2. Floor Mount Bath Mixer Curved

—
VFMMCT + SXFMMIK (Install Kit)

3. Floor Mount Basin Mixer

5 star, 5.5 litres/min ∅

—
VFMBMCT + SXFMMIK (Install Kit)

4. Floor Mount Mixer

—
VFMT
VFMT200T
VFMT250T

+ SXFMMIK (Install Kit)



1. Twin Rail Shower

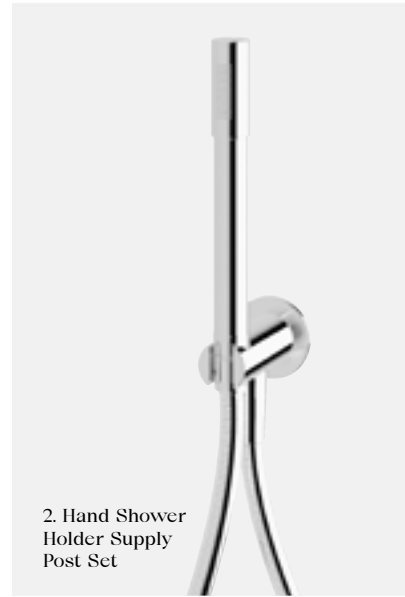

2. Hand Shower Holder Supply Post Set



3. Rail Shower With Hand Held



4. Vertical Shower

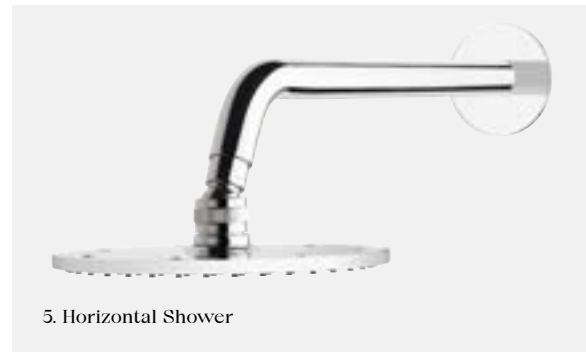

5. Horizontal Shower



6. Wall Sink Set



7. Hob Sink Set



8. Basin Set

Tapsets, Showers & Outlets

The Voda tapsets, shower heads and outlets combine stylish curves with effortless functionality. The elements on each piece are proportional in size.

1. Twin Rail Shower
Top or Bottom inlet available
3 star, 8 litres/min ∅
—
VTRS

2. Hand Shower Holder Supply Post Set
3 star, 8.5 litres/min ∅
—
VXHSSPS

3. Rail Shower With Hand Held
3 star, 8.5 litres/min ∅
—
VRS

4. Vertical Shower
3 star, 8.5 litres/min ∅
—
300mm Arm Model
VVSH3-180
VVSH3-250
500mm Arm Model
VVSH5-180
VVSH5-250

5. Horizontal Shower
180mm and 250mm Head available
3 star, 8.5 litres/min ∅
—
VHSH180
VHSH250

6. Wall Sink Set
Curved and square models available
3 star, 8 litres/min
—
VWSS
VWSISC
VWSISQ

7. Hob Sink Set
3 star, 8 litres/min
—
VHSS

Image: Jessie Prince

8. Basin Set
Curved and square models available
5 star, 5 litres/min
—
VBS
VBSC
VBSQ



7. Wall Basin/Bath Outlet

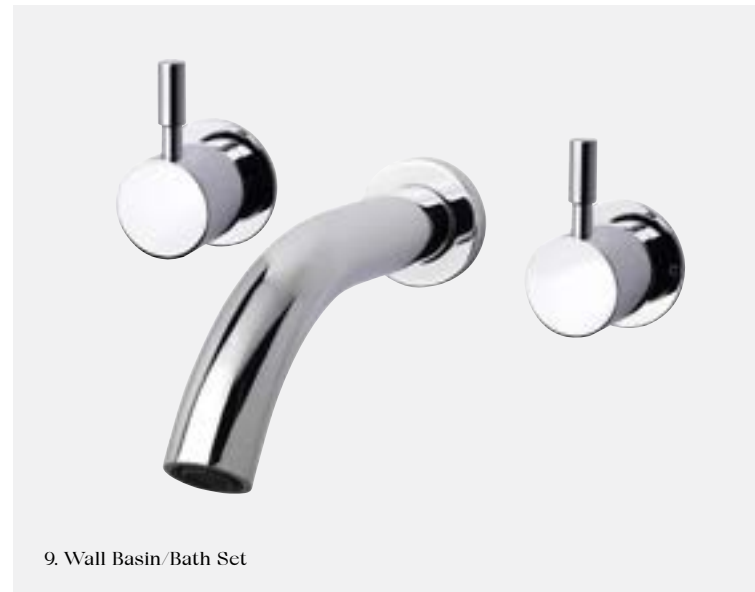

9. Wall Basin/Bath Set



8. Wall Sink Outlet



10. Wall Top Assembly

7. Wall Basin/Bath Outlet

5 star, 5 litres/min ∅

-
- VWB160
- VWB200
- VWB250

Non-restricted model

-
- VBAO160
- VBAO200
- VBAO250

8. Wall Sink Outlet

3 star, 8 litres/min ∅

-
- VWSO

9. Wall Basin/Bath Set

5 star, 5 litres/min ∅

-
- VWBS160
- VWBS200
- VWBS250

Non-restricted model

-
- VBAS160
- VBAS200
- VBAS250

10. Wall Top Assembly

-
- VWTA

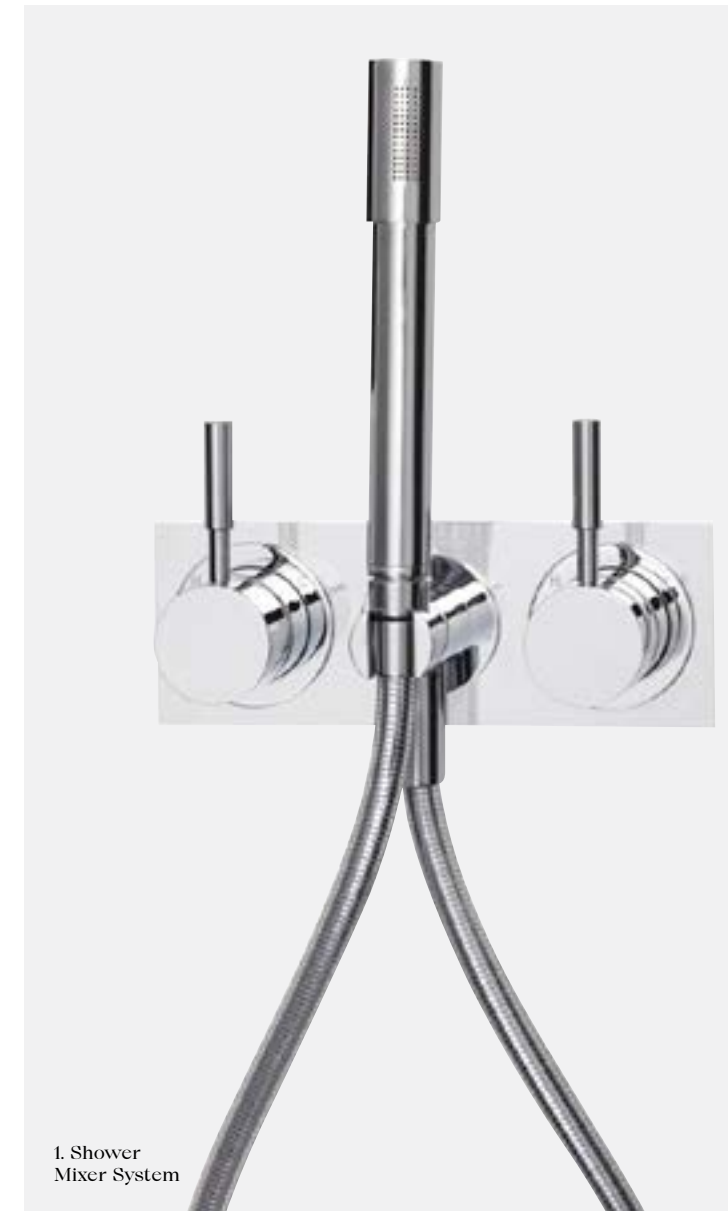

1. Shower Mixer System



2. Shower Mixer Diverter System



3. Mixer Hand Shower System

Mixer Systems

Voda brings a sense of sophisticated simplicity to our mixer systems. All feature the Sussex Masterfit system for ease of installation and a beautiful result.

1. Shower Mixer System

3 star, 8.5 litres/min (hand shower) ∅

-
- VSMS

2. Shower Mixer Diverter System

RH and LH models available

3 star, 8.5 litres/min (hand shower) ∅

-
- VSDSRH

3. Mixer Hand Shower System

RH and LH models available

3 star, 8.5 litres/min (hand shower) ∅

-
- VMHSSRH



4. Bath Mixer System
With Hand Shower

4. Bath Mixer System
With Hand Shower

RH and LH models available
3 star, 8 litres/min (hand shower) Δ

—
VBMS160RH
VBMS200RH
VBMS250RH



5. Bath Mixer
Diverter System
With Hand Shower

5. Bath Mixer Diverter System
With Hand Shower

RH and LH models available
3 star, 8.5 litres/min (hand shower) Δ

—
VBDS160RH
VBDS200RH
VBDS250RH



6. Mixer Diverter
System

6. Mixer Diverter System
RH and LH models available

—
VMDSRH



7. Dual Mixer System

7. Dual Mixer System

—
VDMS



8. Wall Basin/ Bath
Mixer Outlet System

8. Wall Basin/ Bath Mixer Outlet System

RH, LH and vertical models available

5 star, 5 litres/min Δ

—
VWBMS160RH
VWBMS200RH
VWBMS250RH

Non-restricted model

—
VMOS160RH
VMOS200RH
VMOS250RH

Image: Loughlin Furniture Designs

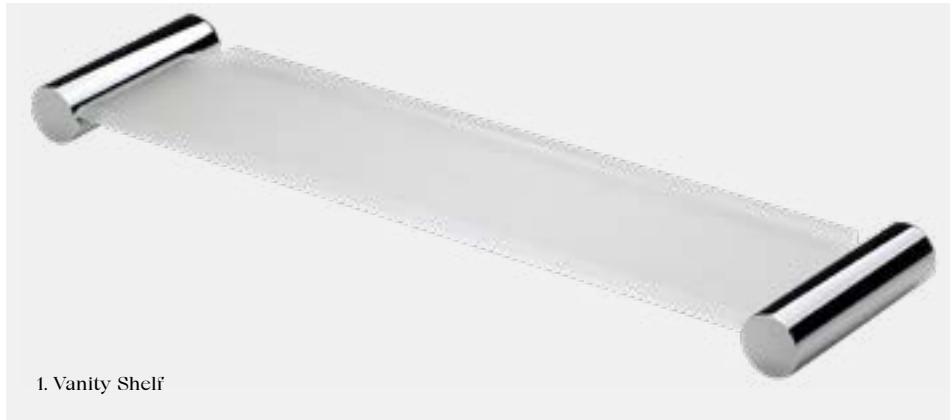

1. Vanity Shelf



2. Shower Shelf



3. Soap Dish



4. Corner Soap Dish



5. Corner Shelf



6. Guest Towel Rail



9. Toilet Roll Holder



10. Guest Towel Ring



7. Towel Rail Single

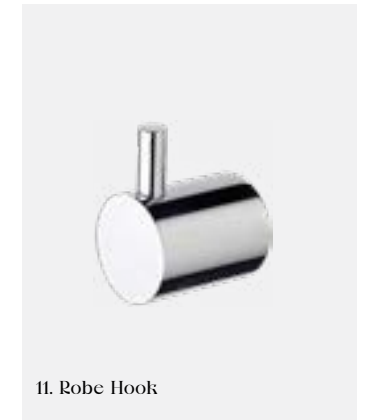

11. Robe Hook



8. Towel Rail Double



12. Double Robe Hook

Accessories

You can continue the curved lines of the Voda style throughout your bathroom. The Voda range of accessories allows you to keep your design consistent.

1. Vanity Shelf

—
VVS450

2. Shower Shelf

—
VSS300

3. Soap Dish

—
VSD150

4. Corner Soap Dish

—
VCSD140

Image: Gavin Scott

5. Corner Shelf

—
VCS180

6. Guest Towel Rail

300mm

—
VGTR300

7. Towel Rail Single

700mm or 900mm

—
VTRS700

VTRS900

8. Towel Rail Double

700mm or 900mm

—
VTRD700

VTRD900

9. Toilet Roll Holder

—
VTRH

10. Guest Towel Ring

—
VGTR

11. Robe Hook

—
VRH

12. Double Robe Hook

—
VDRH

STYLE



Voda
Sink Mixer Curved

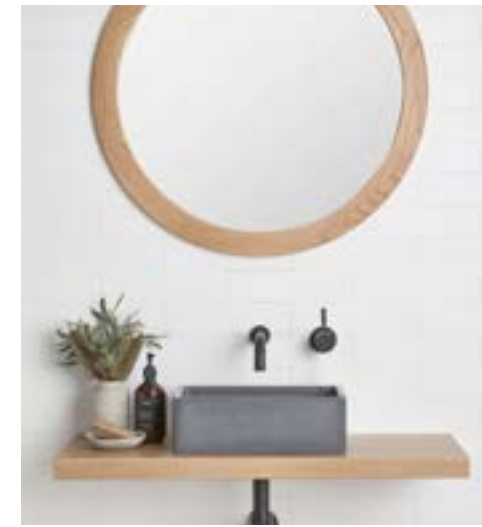

Voda
Wall/Bath Mixer Outlet System
—
MATT BLACK



Voda
Robe Hook
—
LIVING RUSTIC BRONZE



Voda
Sink Mixer Pullout
—
BRUSHED GOLD

Voda is a sophisticated example of Sussex craftsmanship and our engineering heritage.



Lee
National Sales Manager

People

Our greatest treasure
are our incredible
people

What connects us all is our deep sense of passion and pride in our accomplishments. Some of our team has been with us for over 20 years, while others are new talents, but both are driving Sussex forward into a better future.

Our product knowledge, excellent communication skills, and superb attention to detail are a driving force behind the creation of innovative solutions to various problems whether it's related to design, space, or a custom need.

"We sell more than just the product; it's about being adaptive to our clients' needs."



BATHROOM COLLECTIVE



SX

Making it right
entirely in Australia
since 1997